



Zed Extensible Program



Modeling Modular Workbench



Zed Extensible Program

INDEX
ÍNDICE

What is ZEP?
¿Qué es ZEP? _____ **p. 3**

What is ZEP made of?
¿De qué está hecho ZEP? _____ **p. 4**

What makes ZEP unique?
Qué hace único a ZEP? _____ **p. 5**

Who makes ZEP?
Quién hace ZEP? _____ **p. 5**

Components of the system
Componentes del sistema _____ **p. 6**

Sets
Sets _____ **p. 30**

And what now with ZEP?
¿Qué más con ZEP? _____ **p. 36**

Product Guide
Guía de Producto _____ **p. 37**



What is ZEP?
¿Qué es ZEP?

A common mess when modeling.
El desorden más común al modelar.

The ZEP (Zed Extensible Program) system is a modeling product ordering system made up of elements that can be connected to each other, which allows the storage of most of the products currently used in the different stages of scale modelling in a safe, comfortable and accessible way.

El sistema ZEP (Zed Extensible Program) es un sistema de ordenación de productos de modelismo formado por elementos conectables entre sí, que permite almacenar de forma segura, cómoda y accesible la mayoría de los productos usados actualmente en las diferentes fases de elaboración de un modelo a escala.



What is ZEP made of? *¿De qué está hecho ZEP?*

The components of the ZEP system are 3D printed elements using high quality polylactic acid (PLA plastic). This material is a biodegradable polymer made from 100% renewable resources, such as corn, beets, wheat, and other starch-rich products.

Los componentes del sistema ZEP son elementos impresos en 3D utilizando ácido poli-láctico (plástico PLA) de alta calidad. Este material es un polímero biodegradable fabricado a partir de recursos renovables al 100%, como el maíz, la remolacha, el trigo y otros productos ricos en almidón.

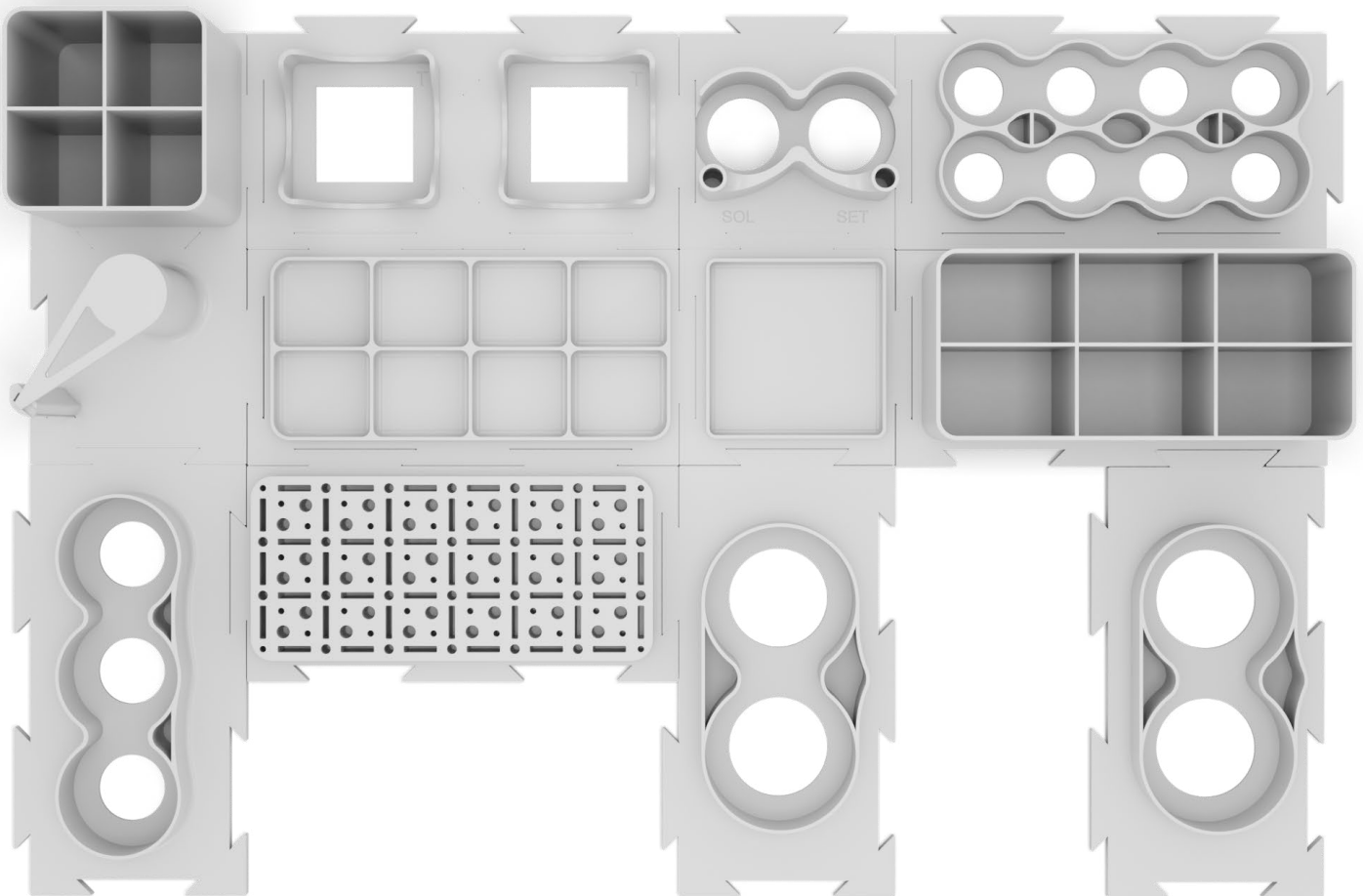
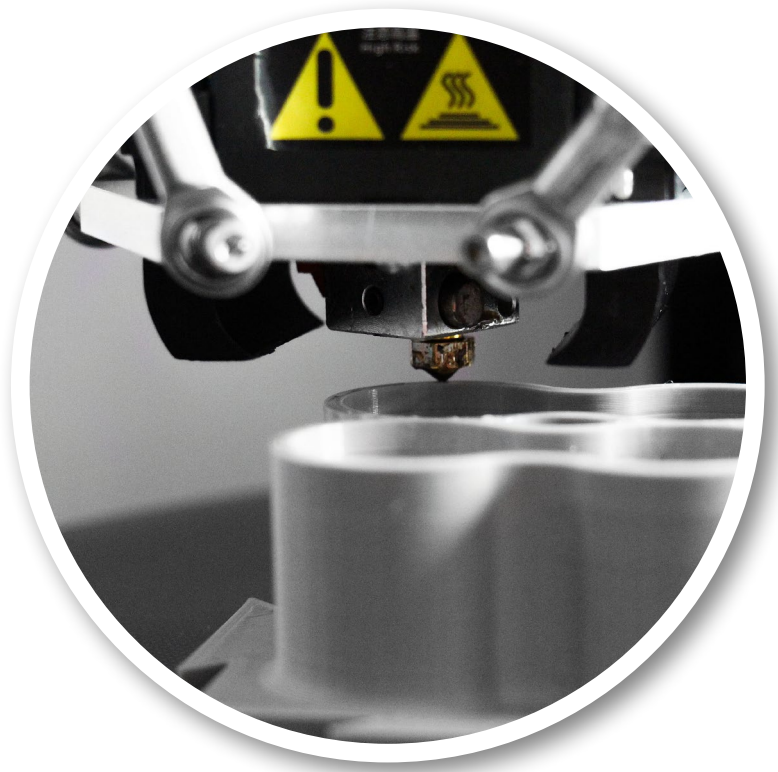

What makes ZEP unique?

¿Qué hace único a ZEP?

- Modular and scalable system
- Rigid connection between components
- Adaptable to your needs
- Repositionable
- Organize and customize your workspace
- Everything in sight
- Avoid accidents and spills with commonly used products
- For all phases of creating your model
- Portable, to take it wherever you want

- Sistema modular y escalable
- Unión rígida entre componentes
- Adaptable a tus necesidades
- Reposicionable
- Ordena y personaliza tu espacio de trabajo
- Todo a la vista
- Evita accidentes y derrames con los productos de uso habitual
- Para todas las fases de la creación de tu modelo a escala
- Portátil, para llevarlo a donde quieras

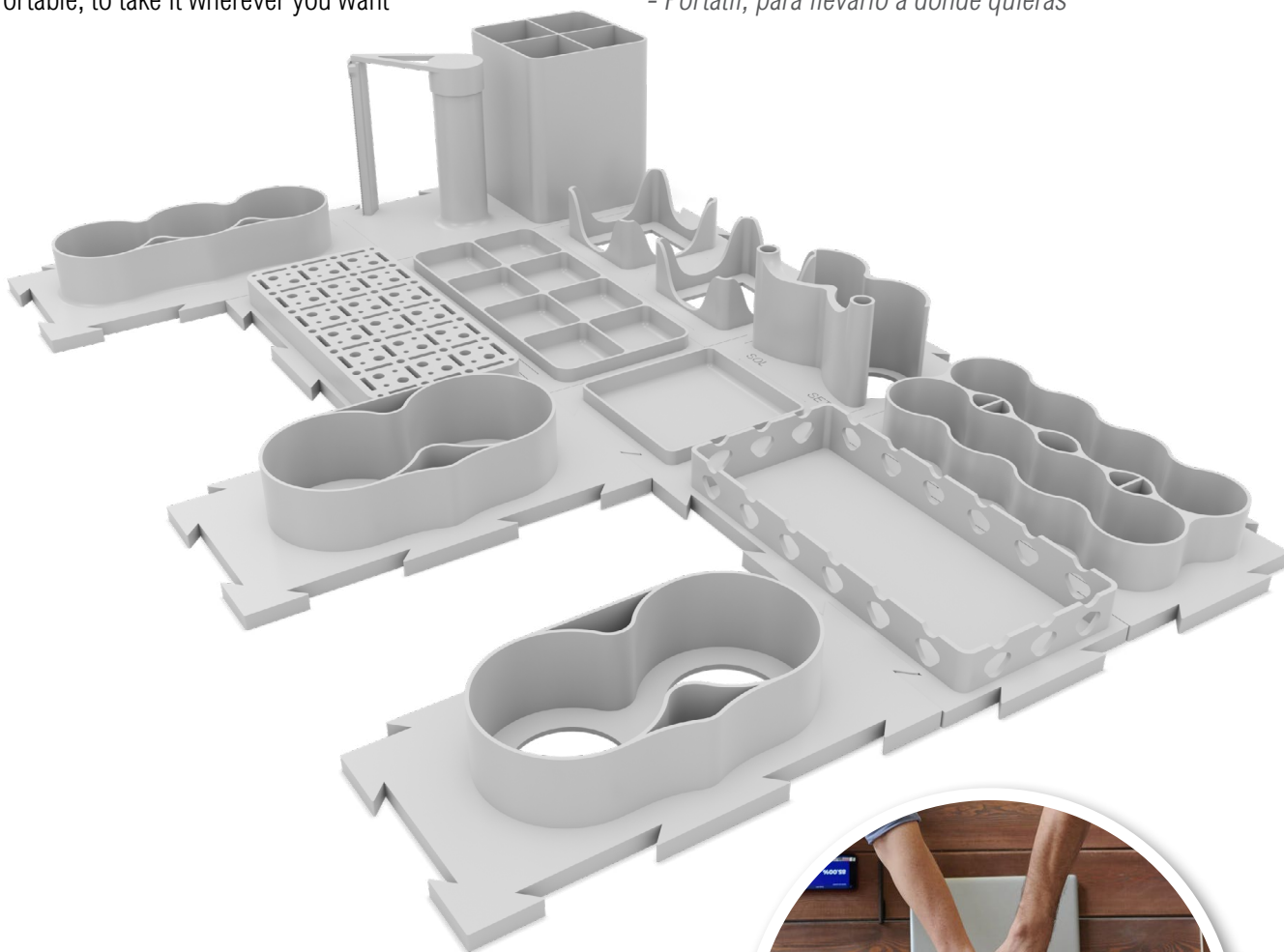

Who makes ZEP?

¿Quién hace ZEP?

The ZEP team is a multidisciplinary group made up of engineers, designers and 3D printing experts. Its objective is to guarantee the best possible user experience through a product designed with precision and manufactured in a unitary way, taking care of every detail.

El equipo de ZEP es un grupo multidisciplinar formado por ingenieros, diseñadores y expertos en impresión 3D. Su objetivo es garantizar la mejor experiencia de usuario posible a través de un producto diseñado con precisión y fabricado de forma unitaria cuidando cada detalle.

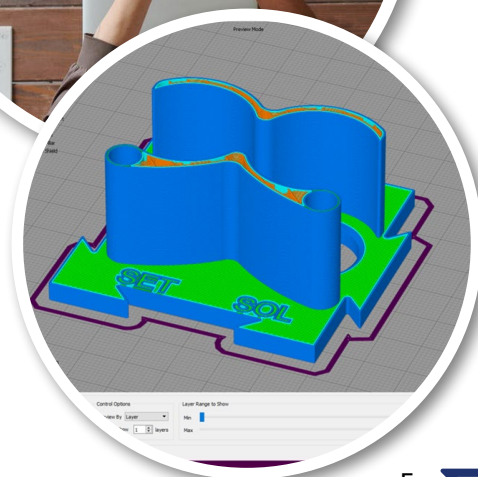



ZEP

Zed Extensible Program

COMPONENTS OF THE SYSTEM
COMPONENTES DEL SISTEMA

Microscale holder
Soporte Microscale

MS101



7.95€

Base to place Microscale products safely. Allows to place two brushes (one for each product). Avoid accidental spills.

Base para colocar productos de Microscale de forma segura. Permite colocar dos pinceles (uno para cada producto). Evita derrames accidentales.

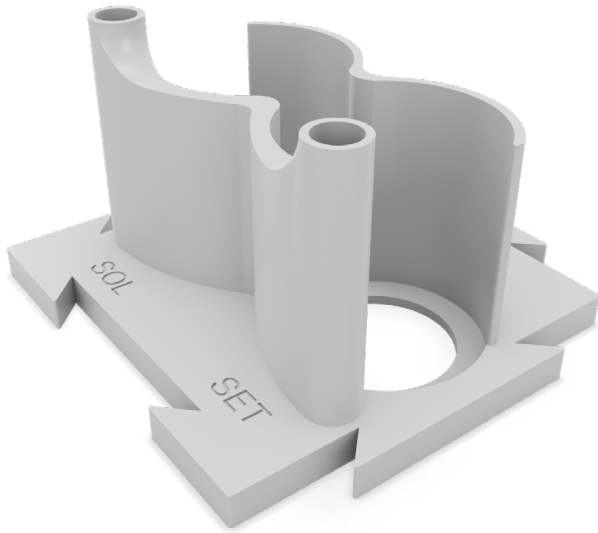

Product in use. Accessories not included
Producto en uso. Accesorios no incluidos

Length / Largo: 70 Width / Ancho: 70 Height / Alto: 42

- Assembly
Montaje
- Paint
Pintura
- Decals
Calcas
- Weathering
Envejecimiento

Tamiya / AK holder
Soporte Tamiya / AK

MS102



5.50€

Stand to safely place Tamiya / AK glues. Avoid accidental spills.

Soporte para colocar de forma segura pegamenteros de Tamiya / AK. Evita derrames accidentales.



Product in use. Accessories not included
Producto en uso. Accesorios no incluidos

Length / Largo: 70 Width / Ancho: 70 Height / Alto: 25

- Assembly
Montaje
- Paint
Pintura
- Decals
Calcas
- Weathering
Envejecimiento

Gunze holder
Soporte Gunze

MS103



5.50€

Stand to safely place the Gunze products. Avoid accidental spills.

Soporte para colocar de forma segura productos de Gunze. Evita derrames accidentales.

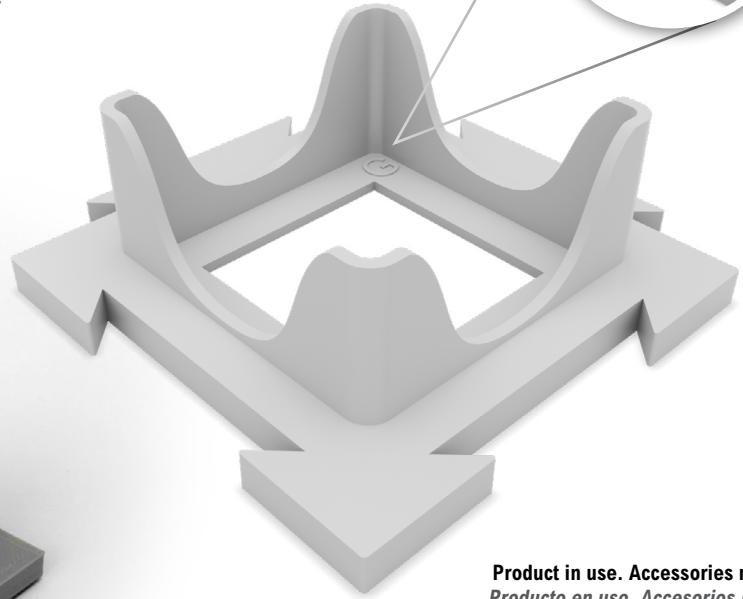

Product in use. Accessories not included
Producto en uso. Accesorios no incluidos

Length / Largo: 70 Width / Ancho: 70 Height / Alto: 25

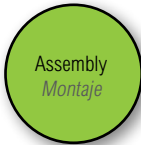

Small decals holder
Base calcas simple

MS104



5.50€

Stand to manipulate small decals.

Soporte para manipular calcas de reducidas dimensiones.

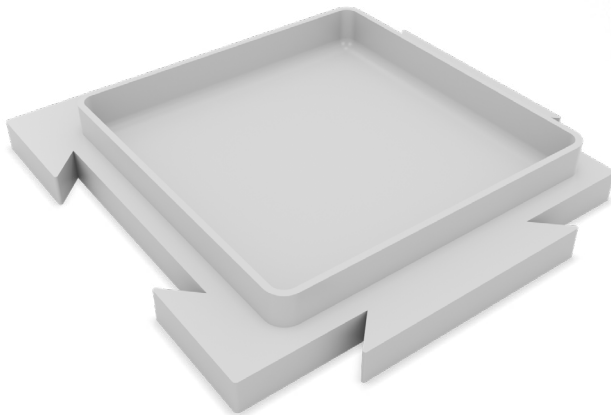

Product in use. Accessories not included
Producto en uso. Accesorios no incluidos

Length / Largo: 70 Width / Ancho: 70 Height / Alto: 10

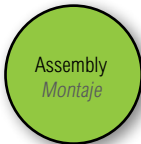

Small tools holder
Soporte portaherramientas simple

MS105



11.50€

Base to place your modeling tools. Small size. It includes 4 internal compartments.

Base simple para colocar de forma accesible tus herramientas de modelismo. Modelo sencillo. Incorpora 4 divisiones interiores.

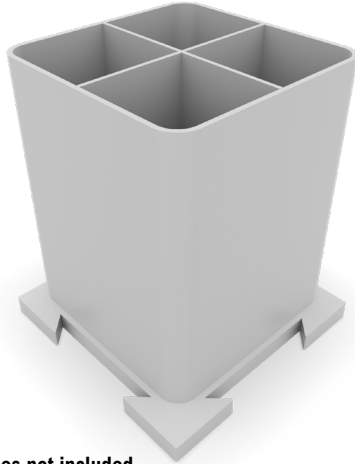

Product in use. Accessories not included
Producto en uso. Accesorios no incluidos

Length / Largo: 70 Width / Ancho: 70 Height / Alto: 70

Assembly
Montaje

Paint
Pintura

Decals
Calcas

Weathering
Envejecimiento



Masking tape holder
Soporte cinta enmascarar

MS106



10.00€

Support to place masking tapes of different widths.
Built-in cutting blade

Soporte para colocar cintas de enmascarar de diferentes anchuras. Incorpora cuchilla de corte.

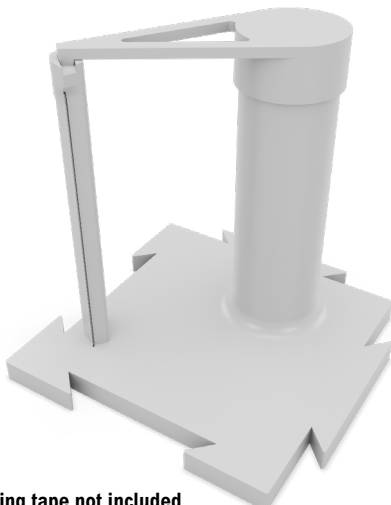

Product in use. Masking tape not included.
Producto en uso. Cinta de enmascarar no incluida.

Length / Largo: 70 Width / Ancho: 70 Height / Alto: 70

Assembly
Montaje

Paint
Pintura

Decals
Calcas

Weathering
Envejecimiento



Multi-container holder
Soporte para contenedores

MS107



7.00€

Holder for cups made of plastic, glass, cardboard, etc. preventing them from tipping over. Maximum bottom diameter: 59mm. It includes 4 compartments for brushes.

Soporte para colocar recipientes o vasos de plástico, cristal, cartón, etc. evitando que se vuelquen. Diámetro inferior máximo: 59mm. Incorpora 4 alojamientos para pinceles.

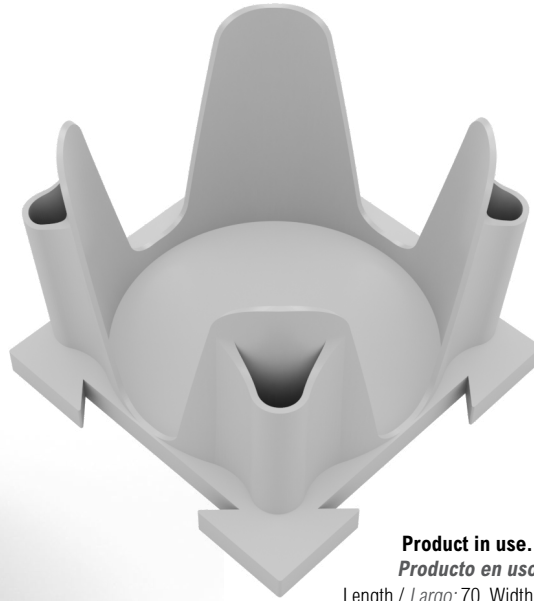

Product in use. Accessories not included

Producto en uso. Accesorios no incluidos

Length / Largo: 70 Width / Ancho: 70 Height / Alto: 50

Assembly
Montaje

Paint
Pintura

Decals
Calcas

Weathering
Envejecimiento

Weathering pencils holder
Soporte para lápices de envejecimiento

MS108



8.00€

Support to place up to 12 AK weathering pencils. Suitable for other general purpose pencils or paints. The shape of the holder prevents damage to the pencil tip.

Soporte para colocar hasta 12 lápices de weathering AK. Válido para otros lápices o pinturas de propósito general. La forma del soporte evita que se dañe la punta del lápiz.

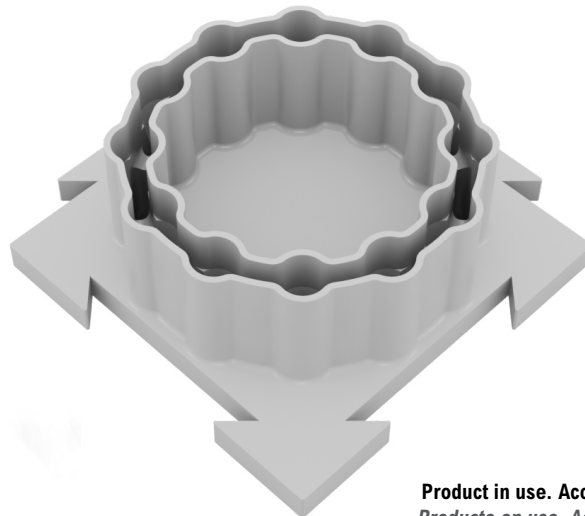

Product in use. Accessories not included

Producto en uso. Accesorios no incluidos

Length / Largo: 70 Width / Ancho: 70 Height / Alto: 25

Assembly
Montaje

Paint
Pintura

Decals
Calcas

Weathering
Envejecimiento

Multipurpose palette Paleta multiusos

MS201



14.50€

Multipurpose support to use as:

- Wet acrylic palette, using the base, hydration towel and hydration paper sheets.
- Oil palette, using the base and absorbent cardboard sheets.
- Support for handling large decals.
- Base for placing parts during assembly Flexible cover included, to avoid paint from drying out between painting sessions. It is semi-transparent to appreciate the content of the palette.

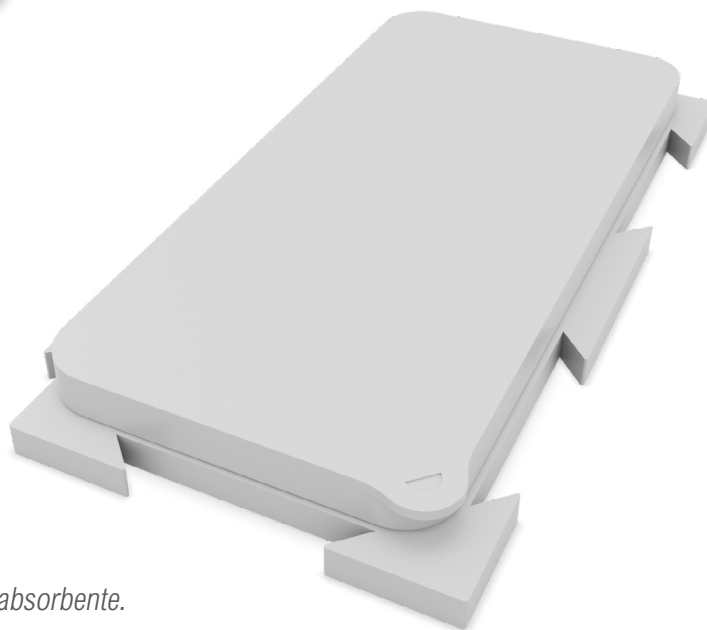

Soporte para múltiples usos, como:

- Paleta húmeda para acrílicos, utilizando la base, la toalla de hidratación y las hojas de papel de hidratación.
- Paleta para óleos, utilizando la base y las hojas de cartón absorbente.
- Soporte para manipular calcas grandes.
- Base para colocar piezas durante el montaje.

Incluye tapa flexible para proteger la pintura de la sequedad entre sesiones de pintura. Es semitransparente para apreciar el contenido de la paleta.

Components included:
Componentes incluidos:



Hidration towel
Toalla de hidratación

Hidration sheets
Hojas de hidratación

Absorbent cardboards
Cartones absorbentes

Palette base ref. MS201-1
Base paleta ref. MS201-1

Flexible cover ref. MS201-2
Tapa flexible ref. MS201-2

Includes / Incluye

MS201-1	Palette base Base paleta
MS201-2	Flexible cover Tapa flexible
	1 Hidration towel 1 Toalla de hidratación
	10 Hidration sheets 10 Hojas de hidratación
	3 Absorbent cardboards 3 Cartones absorbentes

Product in use. Accessories not included
Producto en uso. Accesorios no incluidos

Length / Largo: 135 Width / Ancho: 70 Height / Alto: 12

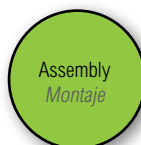

Base with departments
Soporte con departamentos

MS202



7.50€

Support with divisions to facilitate the placement of parts during assembly. Usable for mixing acrylic paints.

Soporte con divisiones para facilitar la colocación de piezas durante el montaje. Válido para realizar mezclas de pinturas acrílicas.



Length / Largo: 135 Width / Ancho: 70 Height / Alto: 10

Product in use. Accessories not included
Producto en uso. Accesorios no incluidos

Assembly
Montaje

Paint
Pintura

Decals
Calcas

Weathering
Envejecimiento

Paint holder x8
Soporte para pinturas x8

MS203



8.50€

Holder to place safely and orderly up to 8 cans of paint. Suitable for any 17ml paint pots (AK, AK 3ª Gen, Vallejo, Panzer Aces, ...). It avoids accidental spills. Incorporates several gaps for brushes.

Soporte para colocar de forma segura y ordenada hasta 8 botes de pintura. Válido para botes de 17ml de cualquier marca (AK, AK 3ª Gen, Vallejo, Panzer Aces, ...). Evita derrames accidentales. Incorpora varios huecos para pinceles.

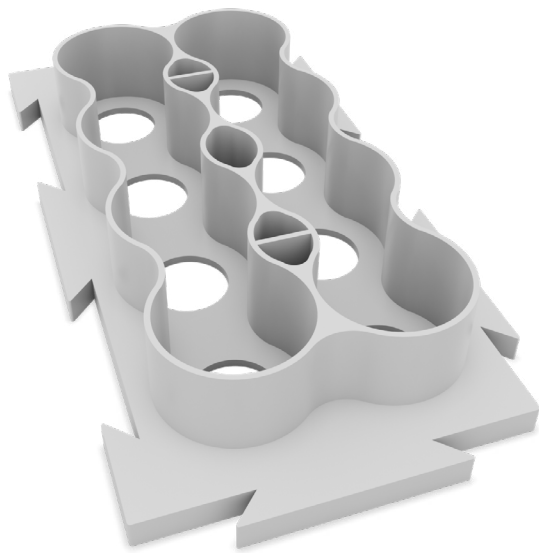

Product in use. Accessories not included
Producto en uso. Accesorios no incluidos

Length / Largo: 135 Width / Ancho: 70 Height / Alto: 30

Assembly
Montaje

Paint
Pintura

Decals
Calcas

Weathering
Envejecimiento

Weatherings holder x3
Soporte para envejecimiento x3

MS204



8.50€

Support to safely place up to 3 cans of weathering products, filters, pigments... Suitable for AK, Sin Industries products... It avoids accidental spills. Includes gaps for brushes.

Soporte para colocar de forma segura hasta 3 botes de productos para tratamientos, filtros, pigmentos... Válido para productos AK, Sin Industries... Evita derrames accidentales. Incorpora alojamientos para pinceles.

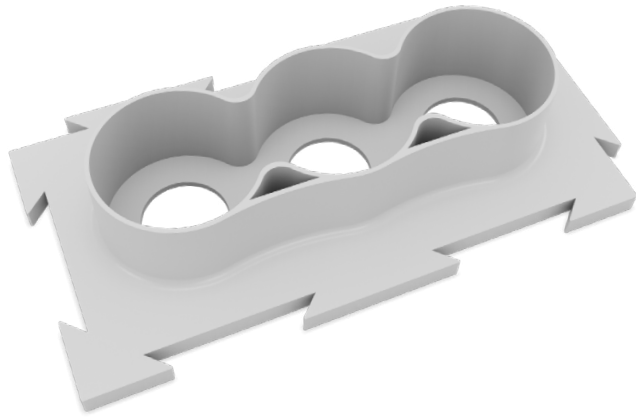

Product in use. Accessories not included
Producto en uso. Accesorios no incluidos

Length / Largo: 135 Width / Ancho: 70 Height / Alto: 25

Assembly
Montaje

Paint
Pintura

Decals
Calcas

Weathering
Envejecimiento

Holder for pieces in painting
Soporte para piezas en pintura

MS205



14.50€

Stand to place safely your pieces during the painting, decals and weathering steps. It incorporates 4 different holes to facilitate operation.

Base para colocar de forma segura tus piezas durante las fases de pintura, calcas y tratamientos. Incorpora agujeros de 4 dimensiones diferentes para facilitar la operación.

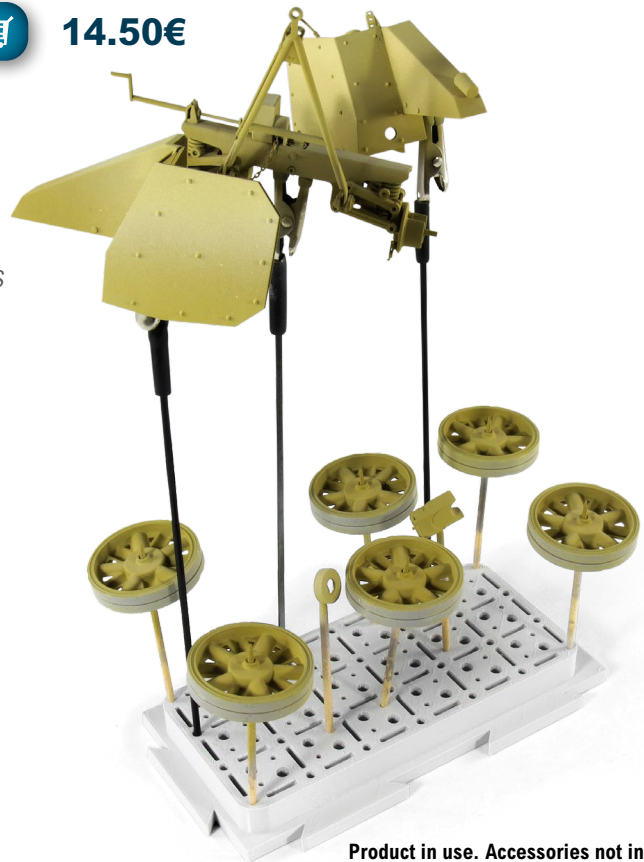
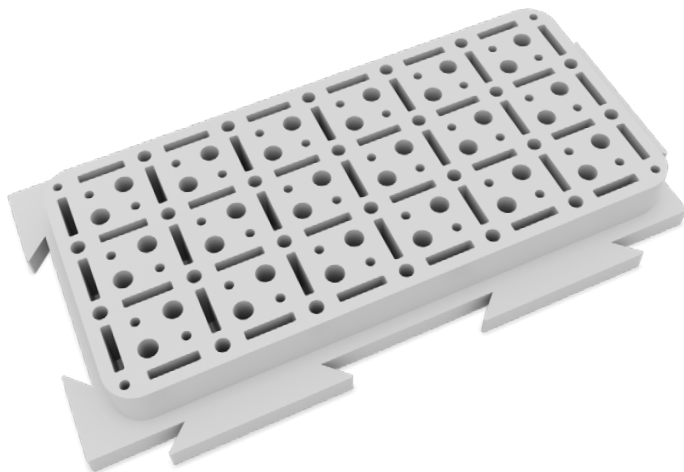

Product in use. Accessories not included
Producto en uso. Accesorios no incluidos

Length / Largo: 135 Width / Ancho: 70 Height / Alto: 15

Assembly
Montaje

Paint
Pintura

Decals
Calcas

Weathering
Envejecimiento

Big tools holder
Soporte portaherramientas grande

MS206



15.50€

Base to place your modeling tools. Large size. It includes 6 internal compartments.

Base para disponer de forma accesible tus herramientas de modelismo. Modelo grande. Incorpora 6 divisiones interiores.



Product in use. Accessories not included
Producto en uso. Accesorios no incluidos

Length / Largo: 135 Width / Ancho: 70 Height / Alto: 60

- Assembly
Montaje
- Paint
Pintura
- Decals
Calcas
- Weathering
Envejecimiento

Soporte para pinceles
Brush holder

MS207



7.50€

Stand to arrange the brushes in an orderly and safe way during the painting and weathering phases. Multiple placement possibilities.

Base para colocar de forma ordenada y segura los pinceles durante las fases de pintura y tratamientos. Múltiples posibilidades de colocación.

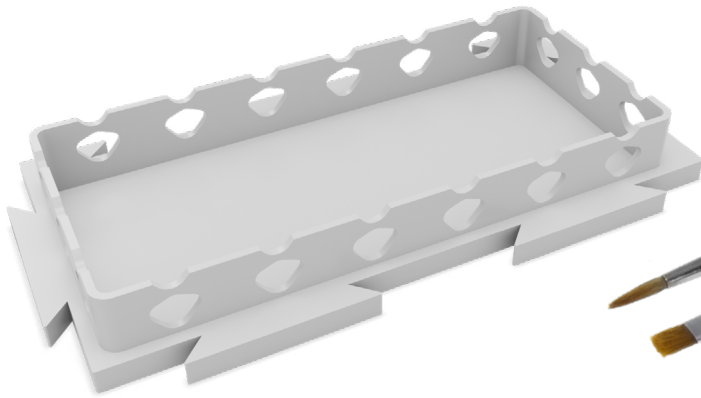

Product in use. Accessories not included
Producto en uso. Accesorios no incluidos

Length / Largo: 135 Width / Ancho: 70 Height / Alto: 18

- Assembly
Montaje
- Paint
Pintura
- Decals
Calcas
- Weathering
Envejecimiento

Solvents holder
Soporte para disolventes

MS208



7.95€

Support to securely place 2 large bottles of solvents, treatment products ... Valid for different brands. Built-in allocations for pipettes or brushes.

Soporte para colocar de forma segura 2 botes grandes de disolventes, productos para tratamientos... Válido para diferentes marcas. Incorpora alojamientos para pipetas o pinceles.

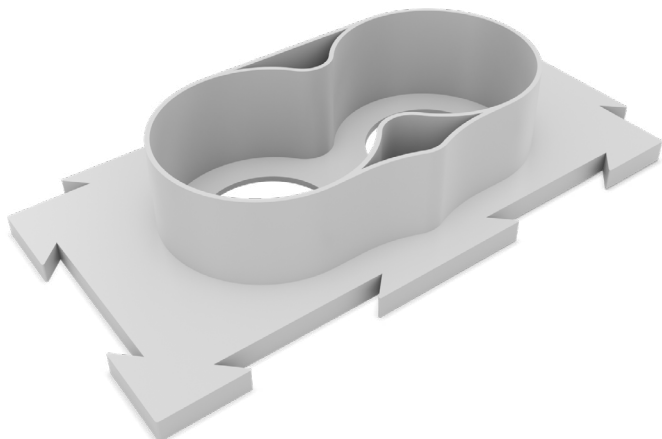

Product in use. Accessories not included
Producto en uso. Accesorios no incluidos

Length / Largo: 135 Width / Ancho: 70 Height / Alto: 25

Assembly
Montaje

Paint
Pintura

Decals
Calcas

Weathering
Envejecimiento

Mixing holder
Soporte para mezclas

MS209



14.50€

Support for mixing paints, pigments, oils, etc. It incorporates 3 metallic containers that adhere to the magnetic base to avoid accidental spills.

Soporte para realizar mezclas de pinturas, pigmentos, óleos, etc. Incorpora 3 recipientes metálicos que se adhieren a la base magnética para evitar vertidos accidentales.



Product in use. Accessories not included
Producto en uso. Accesorios no incluidos

Length / Largo: 135 Width / Ancho: 70 Height / Alto: 5

Assembly
Montaje

Paint
Pintura

Decals
Calcas

Weathering
Envejecimiento

30° connector accessory
Accesorio conector 30°

MSC01



10.50€

Outer connector
Conector exterior

30° Connector accessory to improve the layout of your ZEP composition. 3 units of each are included.

Accesorios de conexión a 30° para mejorar la disposición de tu composición ZEP. Se incluyen 3 unidades de cada pieza.

Inner connector
Conector interior

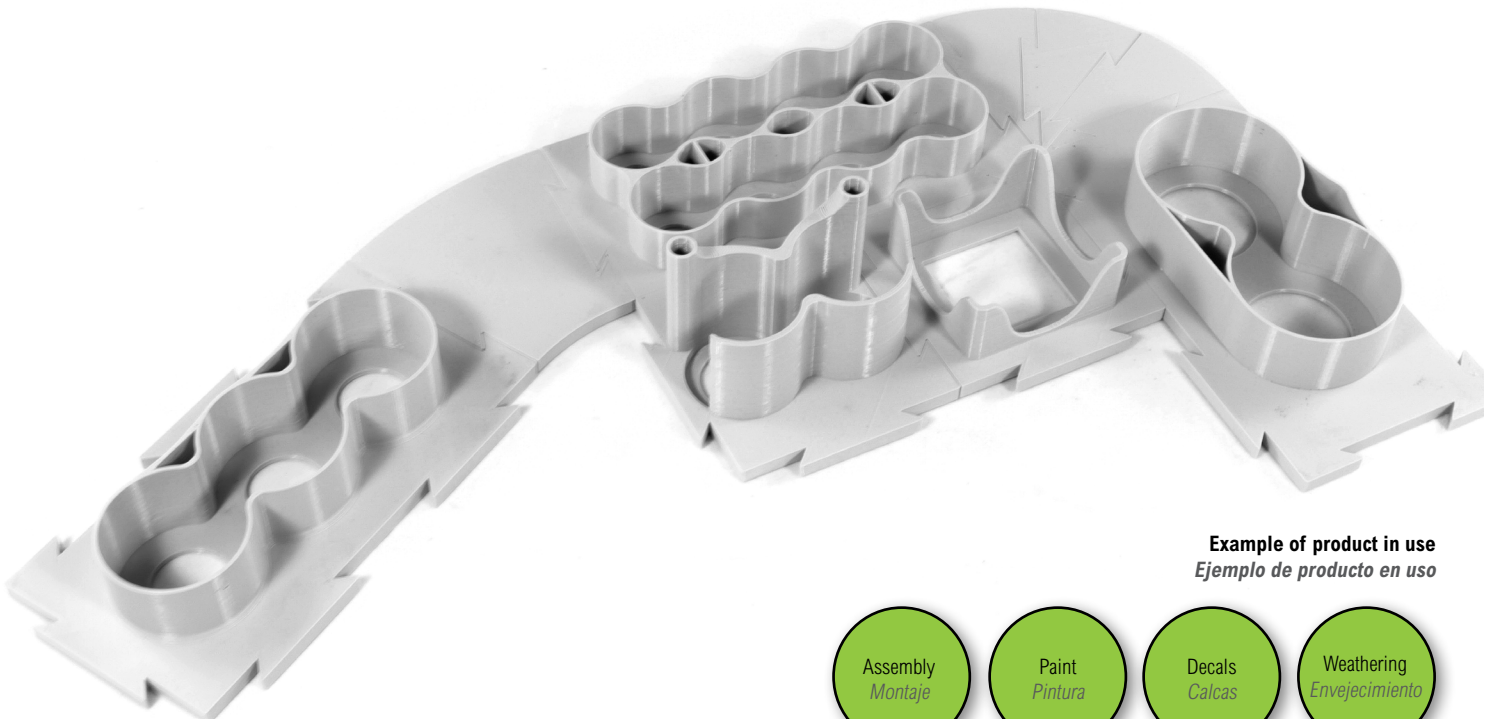
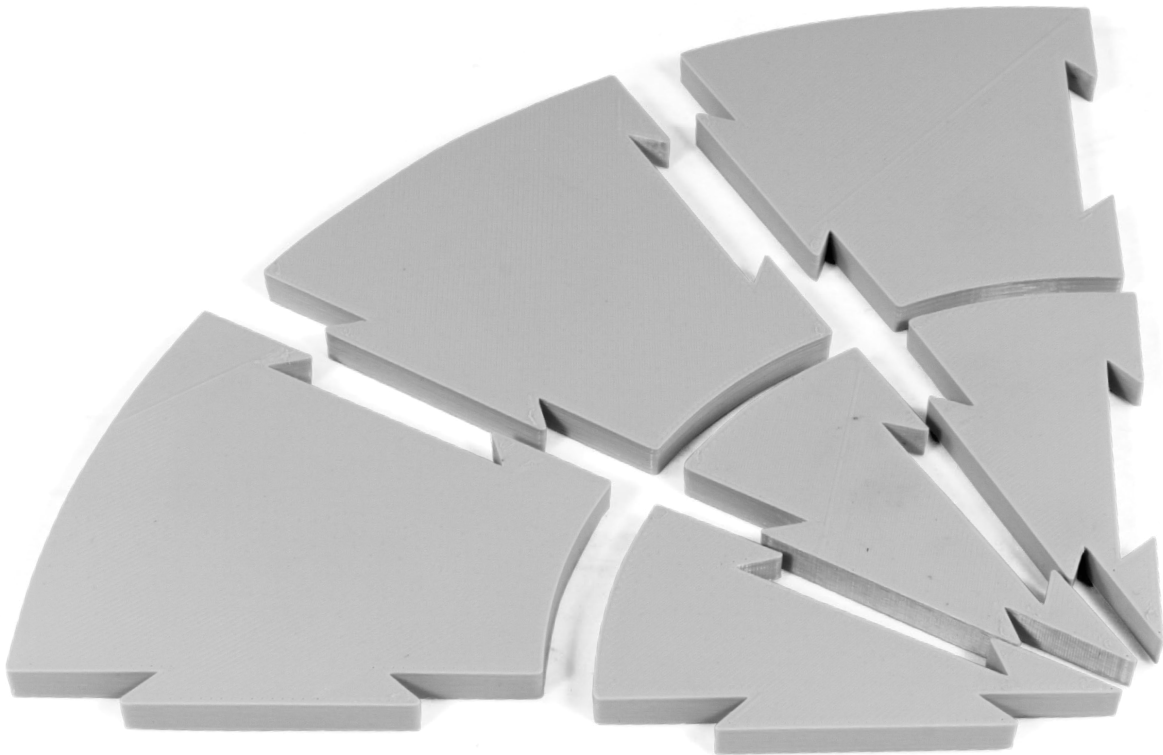
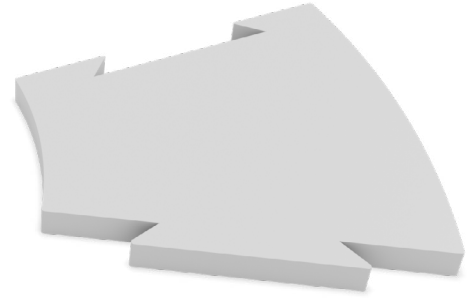
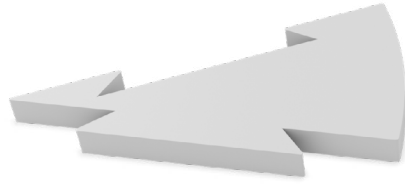

Example of product in use
Ejemplo de producto en uso

Assembly
Montaje

Paint
Pintura

Decals
Calcas

Weathering
Envejecimiento

Desk edges
Bordes de escritorio

MSC02



9.60€

3 units of each
3 unidades de cada

Set of pieces to improve the aesthetics of the edge of the ZEP desk. The set consists of 6 different pieces, which include all the closing possibilities of the system. 3 units each are included, 18 pieces total.

Conjunto de piezas para mejorar la estética del contorno del escritorio ZEP. El conjunto está formado por 6 piezas diferentes, que recogen todas las posibilidades de cierre del sistema. Se incluyen 3 unidades de cada variante, 18 piezas en total.

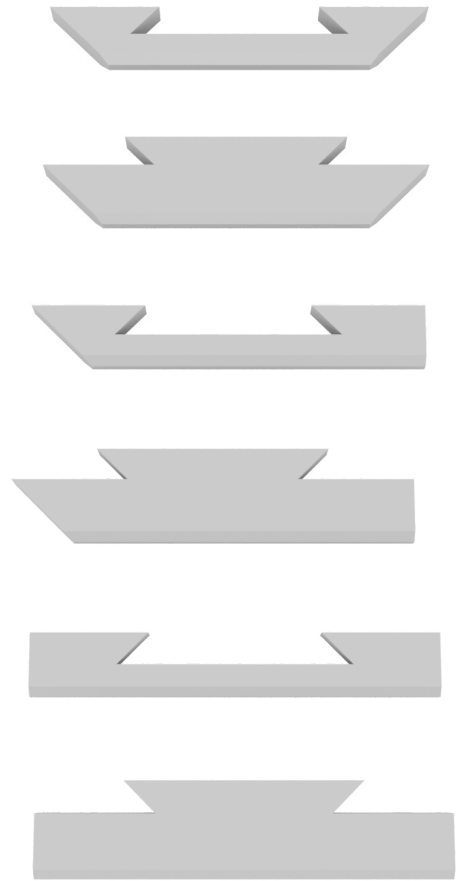

Example of product in use
Ejemplo de producto en uso

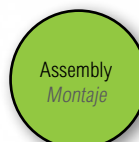

Aircraft holder (Small)
Soporte para aviones (Pequeño)

MSJ01



21.95€

- Support for the assembly, painting, treatment and transport of small-scale aircraft. Light, rigid, high quality and ecological.
- Applicable to 1/72 scale, other scales are possible depending on the size of the model. For other scales, check out our other available sizes.
 - Also applicable to the assembly, painting and treatment of a turret of 1/35 armored vehicles.
 - This support has the dimensions of an A5 size cutting mat and allows you to work comfortably and safely on the model.
 - Supports movable longitudinally and in height. 360 ° swivel supports. Ruler marked on the arms of the base, height reference indications on all supports. Marks for reference of the rotation at the base of the supports.
 - Simple assembly! No need to use glue or trim anything. Maximum assembly time: 3 minutes.
 - Includes stickers to put your name or pseudonym on the base, for when you take photos of your plane. Includes non-slip silicone drops for the base and elastic bands to hold the model for transport to exhibitions, contests, etc.
 - Made in the E.U. with premium quality PLA plastic. Industrially compostable product.

Soporte para el montaje, pintura, tratamiento y transporte de aviones de pequeñas escalas. Ligero, rígido, de gran calidad y ecológico.

- Aplicable a escala 1/72, otras escalas son posibles en función del tamaño de la maqueta. Para otras escalas, mira nuestros otros tamaños disponibles.*
- Aplicable también al montaje, pintura y tratamiento de la torreta de vehículos blindados a 1/35.*
- Este soporte tiene las dimensiones de un tapete de corte de tamaño A5 y permite trabajar de forma cómoda y segura sobre el modelo.*
- Apoyos desplazables longitudinalmente y en altura. Apoyos con giro de 360°. Regla marcada en los brazos de la base, indicaciones de referencia de altura en todos los apoyos. Marcas para referencia del giro en la base de los apoyos.*
- Montaje sencillo! No es necesario usar pegamento ni recortar nada. Tiempo máximo de montaje: 3 minutos.*
- Incluye pegatinas para poner tu nombre o seudónimo en la base, para cuando hagas fotos a tu avión. Incluye gotas de silicona antideslizantes para la base y gomas elásticas para la sujeción del modelo para el transporte a exposiciones, concursos, etc.*
- Fabricado en la U.E. con plástico PLA de calidad premium. Producto compostable industrialmente.*

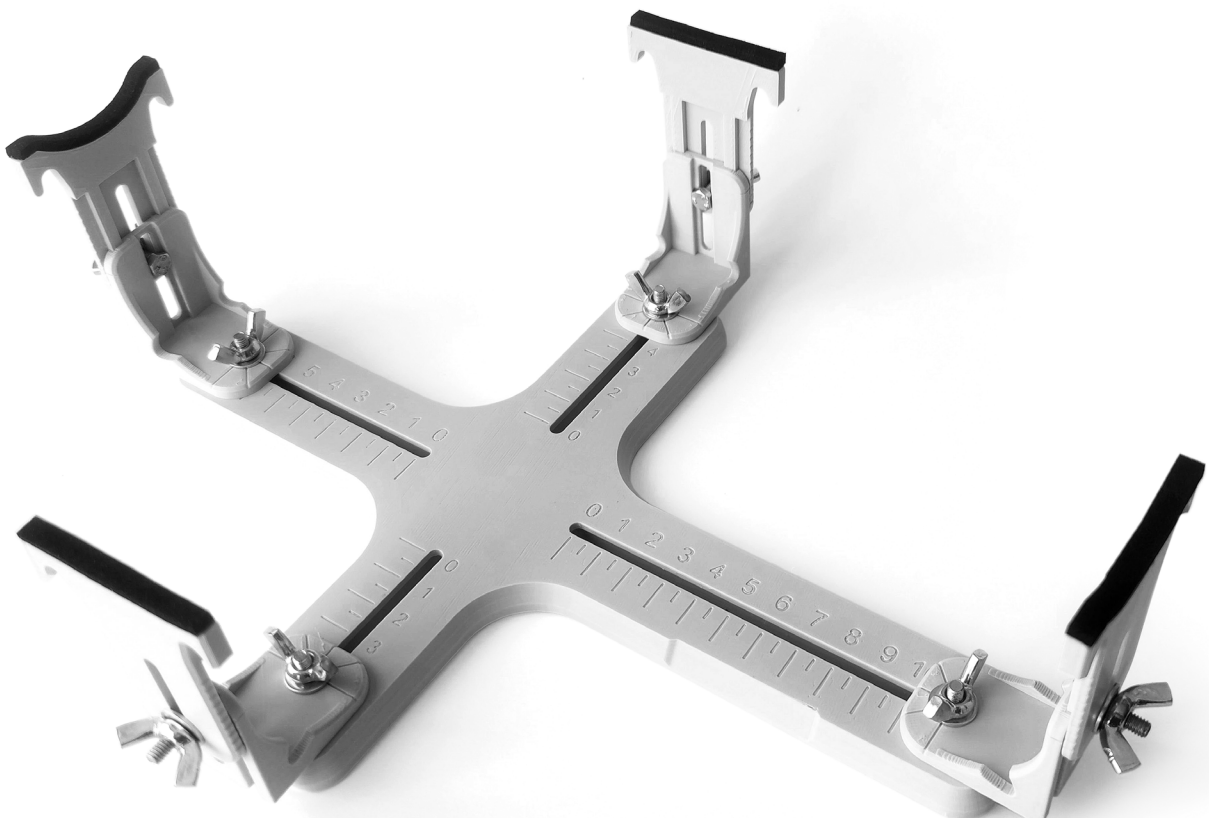

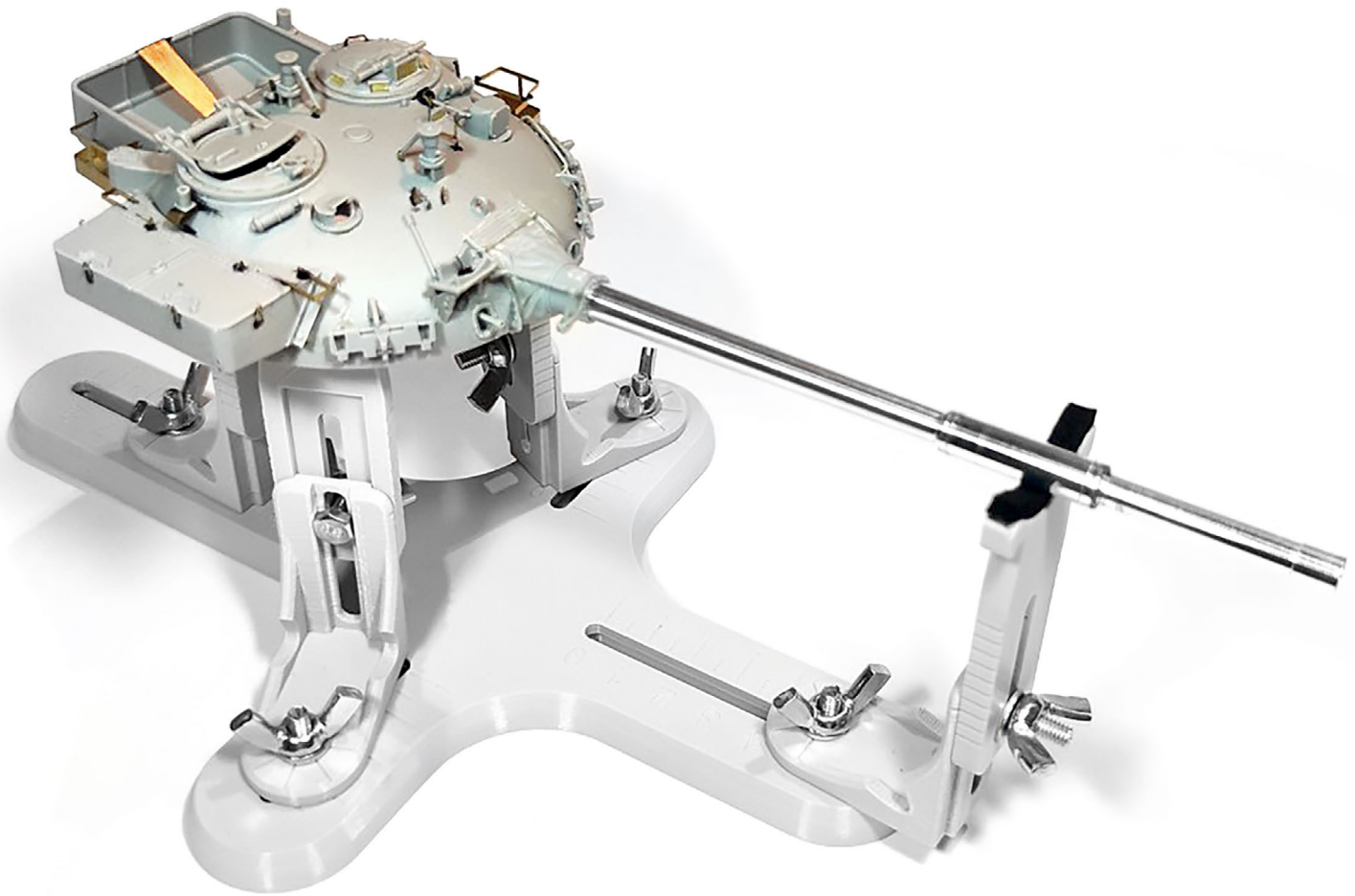
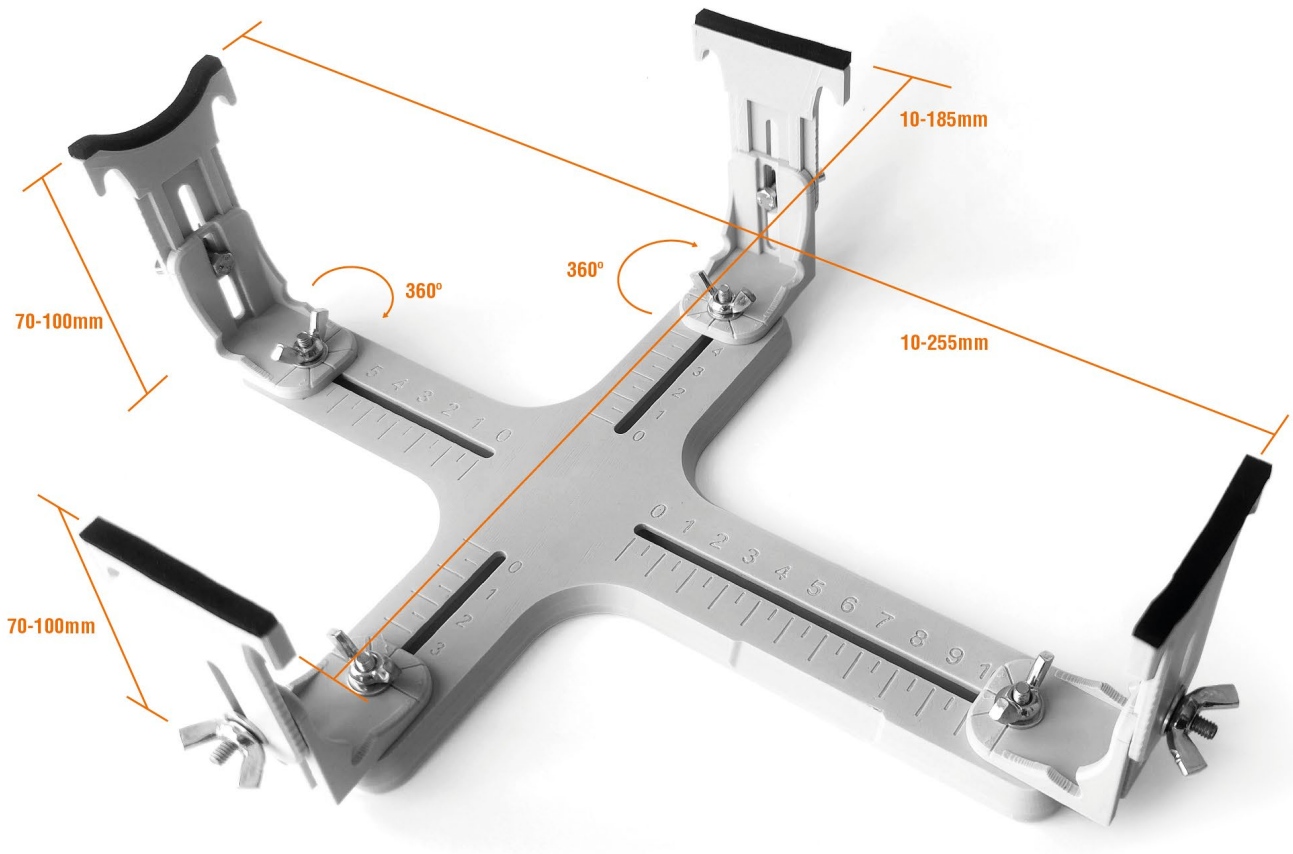

Example of product in use
Ejemplo de producto en uso

- Assembly
Montaje
- Paint
Pintura
- Decals
Calcas
- Weathering
Envejecimiento

Aircraft holder (Medium)
Soporte para aviones (Mediano)

MSJ02



29,95€

Support for the assembly, painting, treatment and transport of medium-scale aircraft. Light, rigid, high quality and ecological.

- Applicable to 1/48 scale aircraft and reactors, other scales are possible depending on the size of the model. For other scales, check out our other available sizes.
- This support has the dimensions of an A4 size cutting mat and allows you to work comfortably and safely on the model.
- Supports movable longitudinally and in height. 360 ° swivel supports. Ruler marked on the arms of the base, height reference indications on all supports. Marks for reference of the rotation at the base of the supports.
- Simple assembly! No need to use glue or trim anything. Maximum assembly time: 3 minutes.
- Includes stickers to put your name or pseudonym on the base, for when you take photos of your plane. Includes non-slip silicone drops for the base and elastic bands to hold the model for transport to exhibitions, contests, etc.
- Made in the E.U. with premium quality PLA plastic. Industrially compostable product.

Soporte para el montaje, pintura, tratamiento y transporte de aviones de escalas intermedias. Ligero, rígido, de gran calidad y ecológico.

- *Aplicable a aviones y reactores a escala 1/48, otras escalas son posibles en función del tamaño de la maqueta. Para otras escalas, mira nuestros otros tamaños disponibles.*
- *Este soporte tiene las dimensiones de un tapete de corte de tamaño A4 y permite trabajar de forma cómoda y segura sobre el modelo.*
- *Apoyos desplazables longitudinalmente y en altura. Apoyos con giro de 360°. Regla marcada en los brazos de la base, indicaciones de referencia de altura en todos los apoyos. Marcas para referencia del giro en la base de los apoyos.*
- *Montaje sencillo! No es necesario usar pegamento ni recortar nada. Tiempo máximo de montaje: 3 minutos.*
- *Incluye pegatinas para poner tu nombre o seudónimo en la base, para cuando hagas fotos a tu avión. Incluye gotas de silicona antideslizantes para la base y gomas elásticas para la sujeción del modelo para el transporte a exposiciones, concursos, etc.*
- *Fabricado en la U.E. con plástico PLA de calidad premium. Producto compostable industrialmente.*

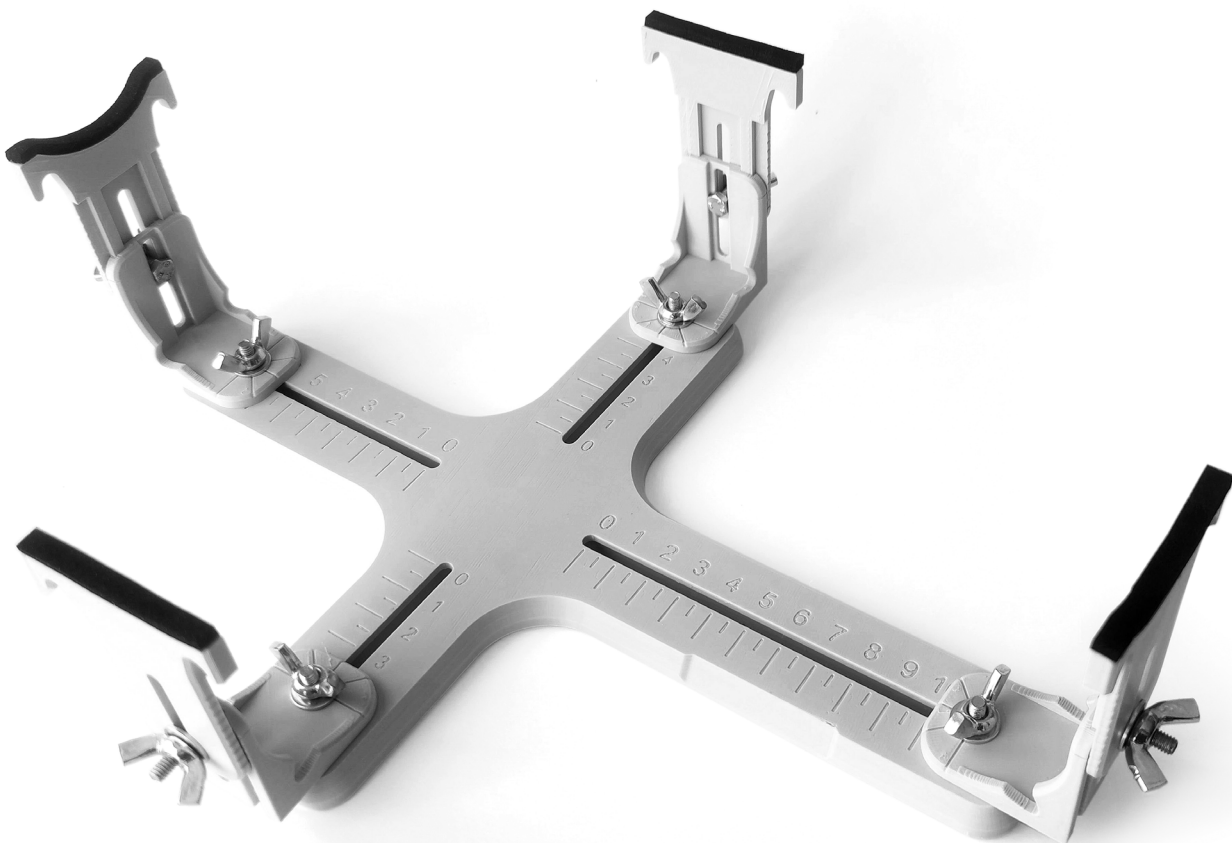

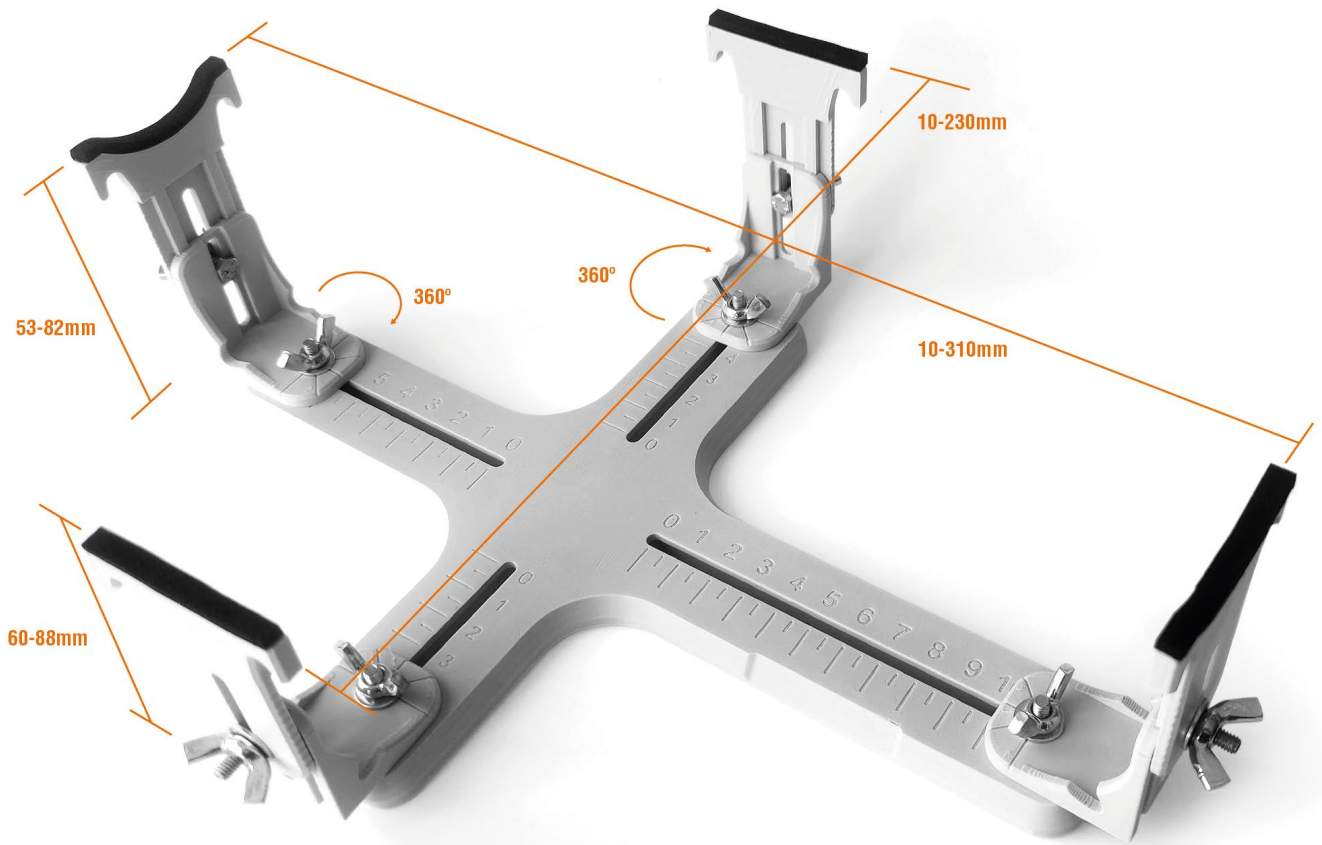

Example of product in use
Ejemplo de producto en uso

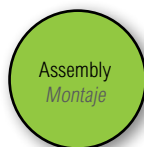

Aircraft holder (Large)
Soporte para aviones (Grande)

MSJ03



35,95€

Support for the assembly, painting, treatment and transport of large-scale aircraft. Light, rigid, high quality and ecological.

- Applicable to 1/32 and 1/24 scales, other scales are possible depending on the size of the model. For other scales, check out our other available sizes.
- This stand has the dimensions of an A3-size cutting mat and allows you to work comfortably and safely on the model.
- Supports movable longitudinally and in height. 360 ° swivel supports. Ruler marked on the arms of the base, height reference indications on all supports. Marks for reference of the rotation at the base of the supports.
- Simple assembly! No need to use glue or trim anything. Maximum assembly time: 3 minutes.
- Includes stickers to put your name or pseudonym on the base, for when you take photos of your plane. Includes non-slip silicone drops for the base and elastic bands to hold the model for transport to exhibitions, contests, etc.
- Made in the E.U. with premium quality PLA plastic. Industrially compostable product.

Soporte para el montaje, pintura, tratamiento y transporte de aviones de grandes escalas. Ligero, rígido, de gran calidad y ecológico.

- Aplicable a escalas 1/32 y 1/24, otras escalas son posibles en función del tamaño de la maqueta. Para otras escalas, mira nuestros otros tamaños disponibles*
- Este soporte tiene las dimensiones de un tapete de corte de tamaño A3 y permite trabajar de forma cómoda y segura sobre el modelo.*
- Apoyos desplazables longitudinalmente y en altura. Apoyos con giro de 360°. Regla marcada en los brazos de la base, indicaciones de referencia de altura en todos los apoyos. Marcas para referencia del giro en la base de los apoyos.*
- Montaje sencillo! No es necesario usar pegamento ni recortar nada. Tiempo máximo de montaje: 3 minutos.*
- Incluye pegatinas para poner tu nombre o seudónimo en la base, para cuando hagas fotos a tu avión. Incluye gotas de silicona antideslizantes para la base y gomas elásticas para la sujeción del modelo para el transporte a exposiciones, concursos, etc.*
- Fabricado en la U.E. con plástico PLA de calidad premium. Producto compostable industrialmente.*

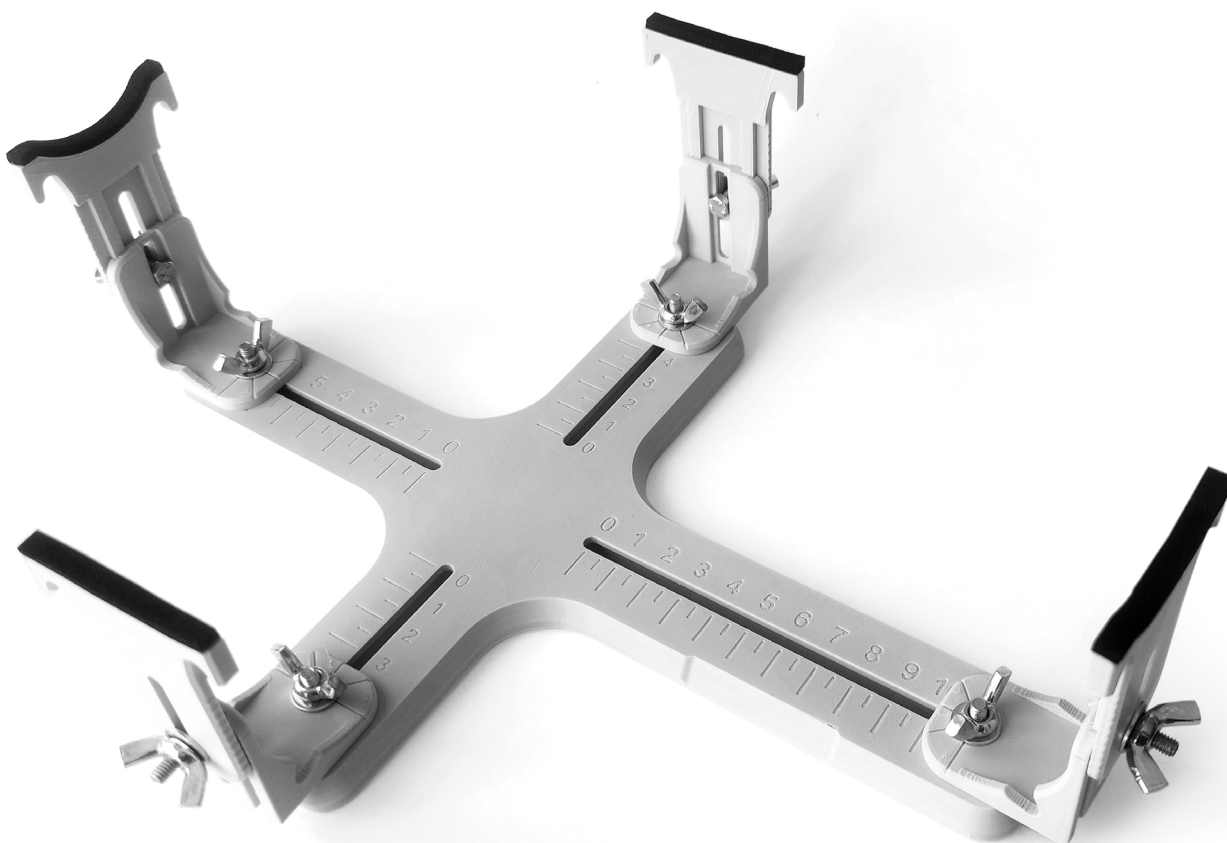

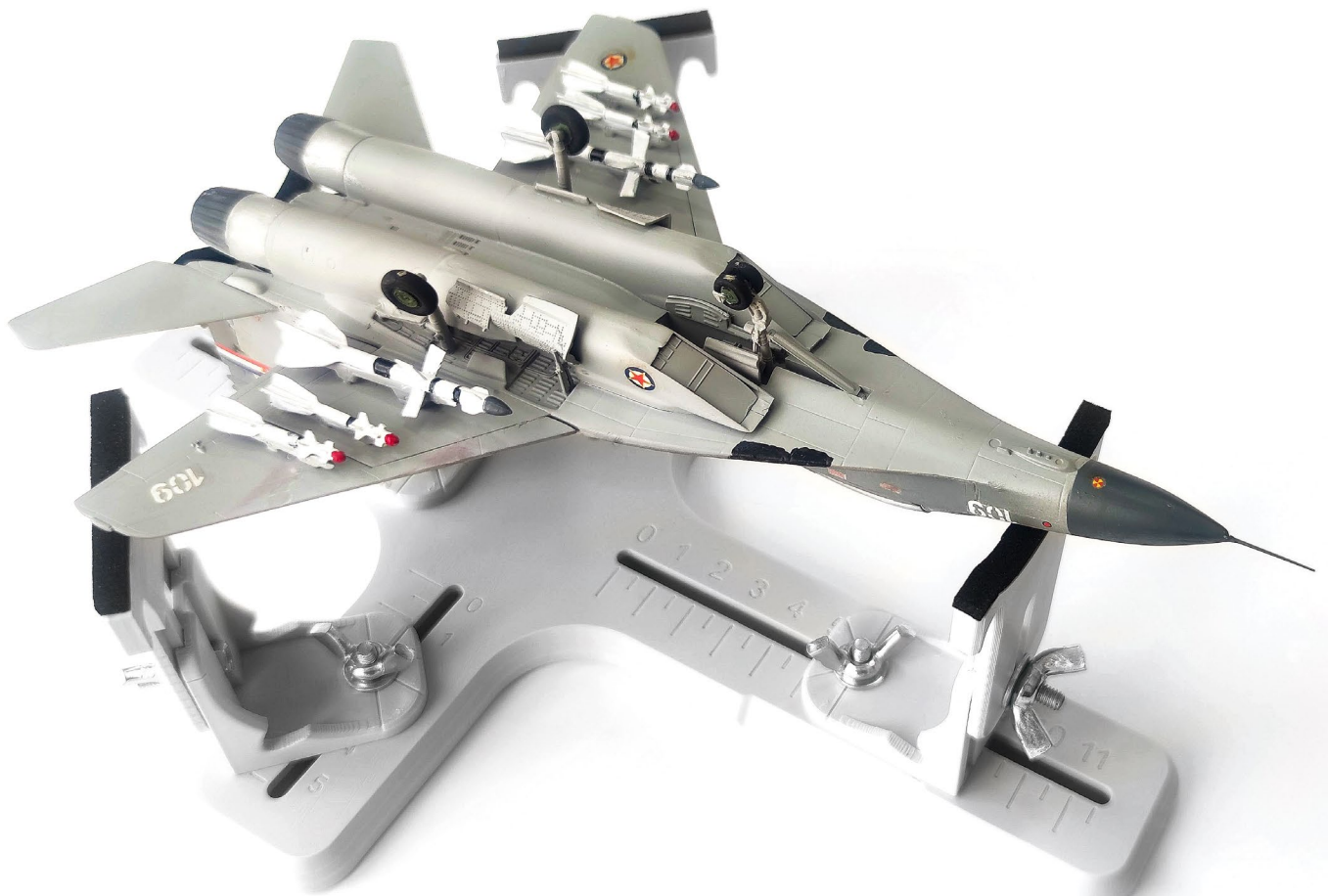
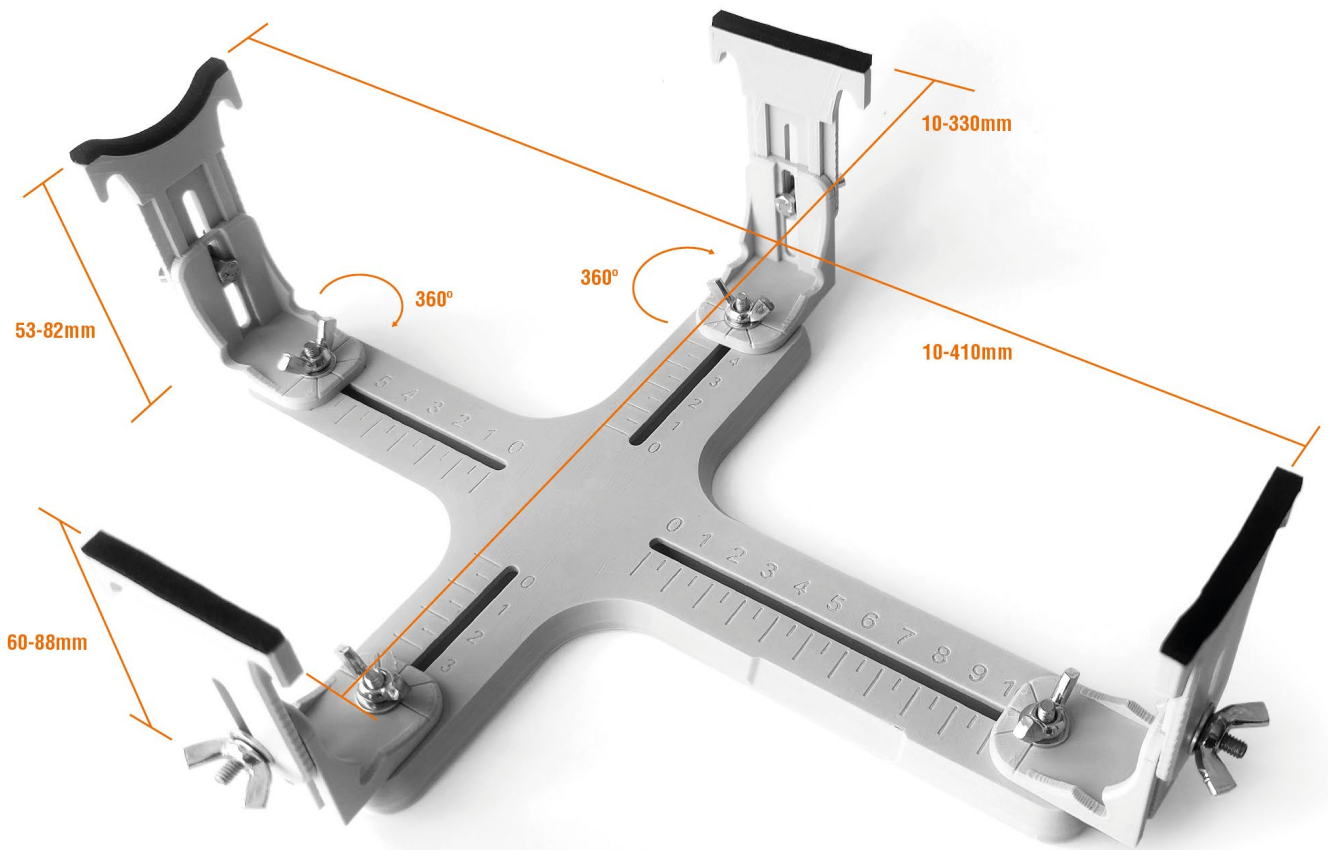

Example of product in use
Ejemplo de producto en uso

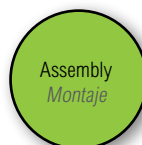

Rotary base
Base giratoria

MSJ04



15€

General type rotary base for assembly, painting, treatment, etc. phases. Compatible with ZEP aircraft jigs.

Base giratoria de tipo general para las fases de montaje, pintura, tratamiento... Compatible con los soportes para aviones.

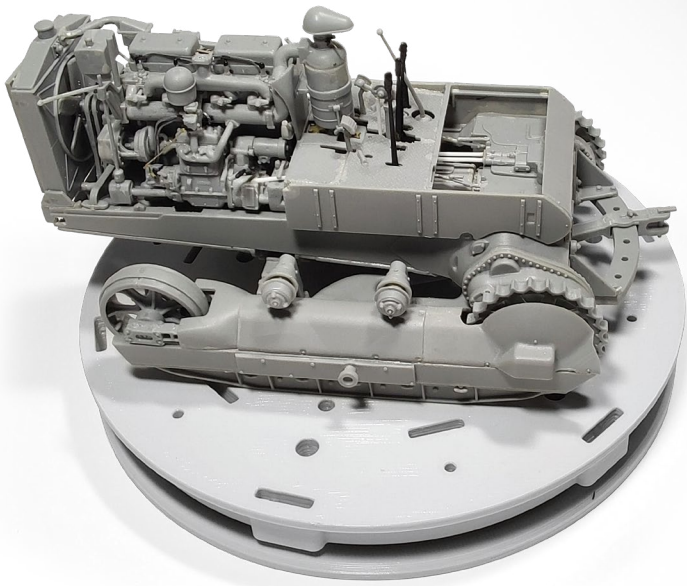
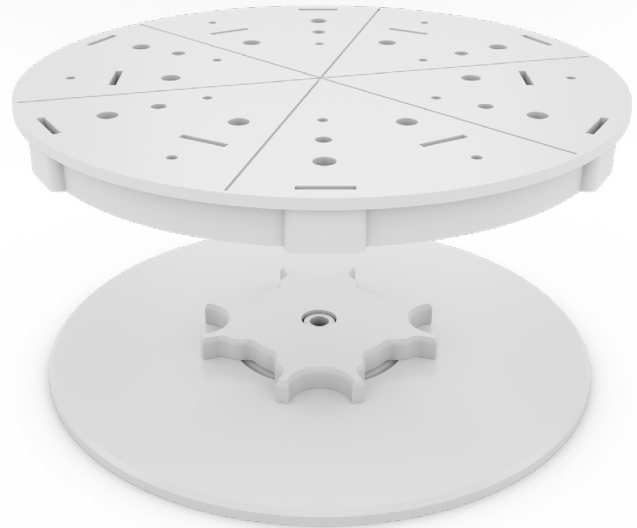
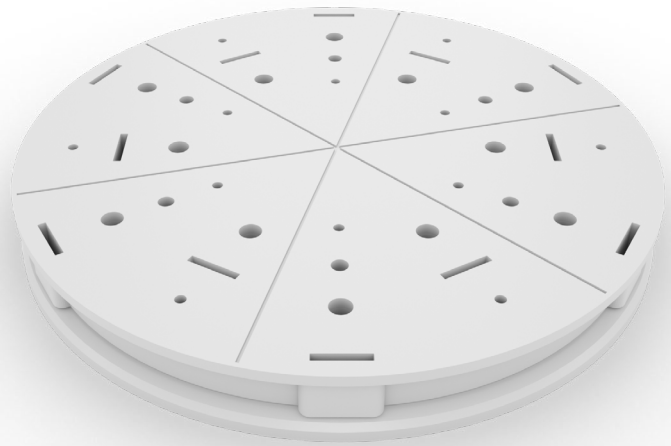



Example of product in use
Ejemplo de producto en uso

Assembly
Montaje

Paint
Pintura

Decals
Calcas

Weathering
Envejecimiento

Vehicles Jig
Soporte para vehículos

MSJ05



29.95€

Tool for holding armored vehicles, tanks, trucks, civil vehicles, etc. during the assembly, painting, decals and weathering phases. Various ways to hold your model. Special accessory to hold the turret, included.

Herramienta para la sujeción de vehículos blindados, carros de combate, camiones, vehículos civiles, etc. durante las fases de montaje, pintura, calcas y tratamiento. Varias opciones de sujeción del modelo. Incluido accesorio especial para la sujeción de la torreta.



Holding by arms.
Sujeción mediante brazos.



Holding by the hull.
Sujeción por el casco.

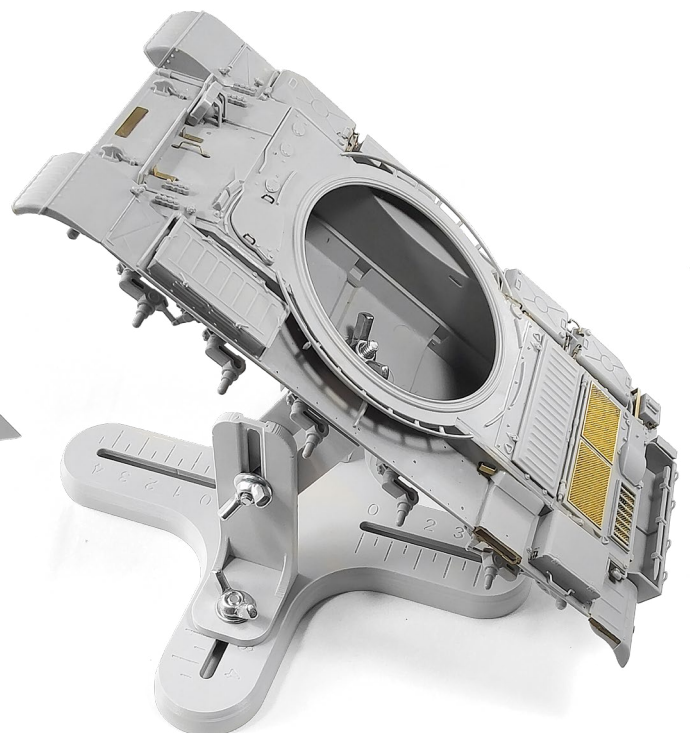

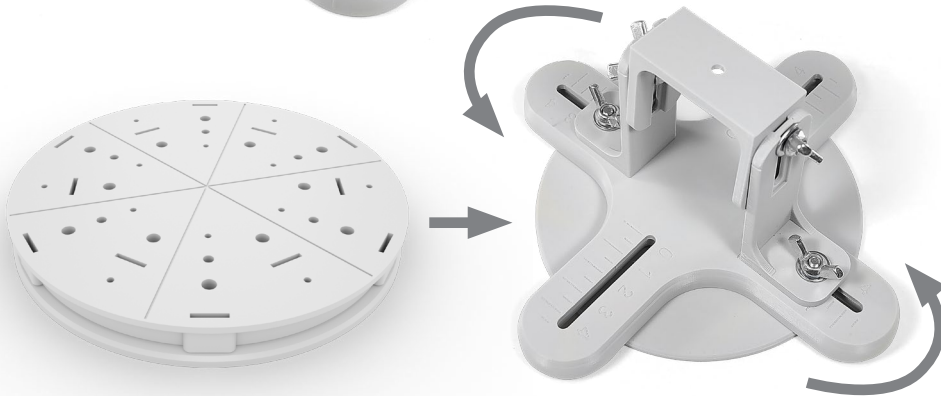
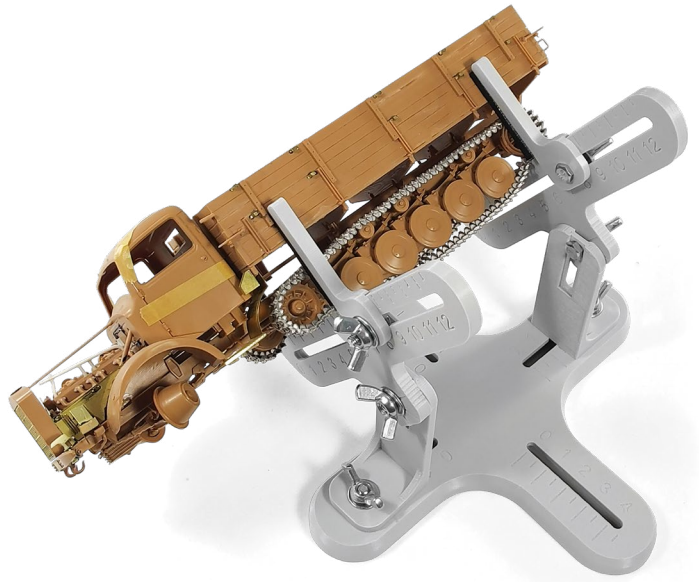

It can also be used with MSJ04 Rotary base.
También se puede usar con MSJ04 Base giratoria.

Example of product in use
Ejemplo de producto en uso

Assembly
Montaje

Paint
Pintura

Decals
Calcas

Weathering
Envejecimiento

Sanding holder small
SopORTE para lijas
pequeño

MSA01



8.95€

Set of 4 supports for sandpaper of different color, allows to place sandpaper with different grits, identifying each of them by the color of the tool. For example:

- In black, the thickest, for example: nº 360
- In dark gray, nº 800
- In light gray, nº 2.000
- On target, the finest. For example: nº 4.000

Conjunto de 4 soportes para lija de diferente color, permite para colocar lija con diferentes grados, identificando cada uno de ellos por el color de la herramienta. Por ejemplo:

- En el negro, el más grueso, por ejemplo: nº360
- En el gris oscuro, nº 800
- En el gris claro, nº 2.000
- En el blanco, el más fino. Por ejemplo: nº 4.000

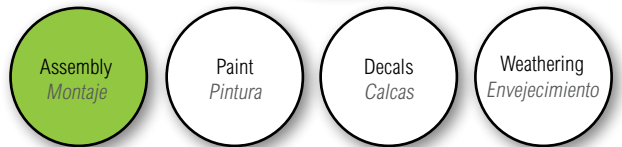

Sanding holder large
SopORTE para lijas
grande

MSA02



15.50€

Set of 4 supports for sandpaper of different color, allows to place sandpaper with different grits, identifying each of them by the color of the tool. For example:

- In black, the thickest, for example: nº 360
- In dark gray, nº 800
- In light gray, nº 2.000
- On target, the finest. For example: nº 4.000

Conjunto de 4 soportes para lija de diferente color, permite para colocar lija con diferentes grados, identificando cada uno de ellos por el color de la herramienta. Por ejemplo:

- En el negro, el más grueso, por ejemplo: nº360
- En el gris oscuro, nº 800
- En el gris claro, nº 2.000
- En el blanco, el más fino. Por ejemplo: nº 4.000

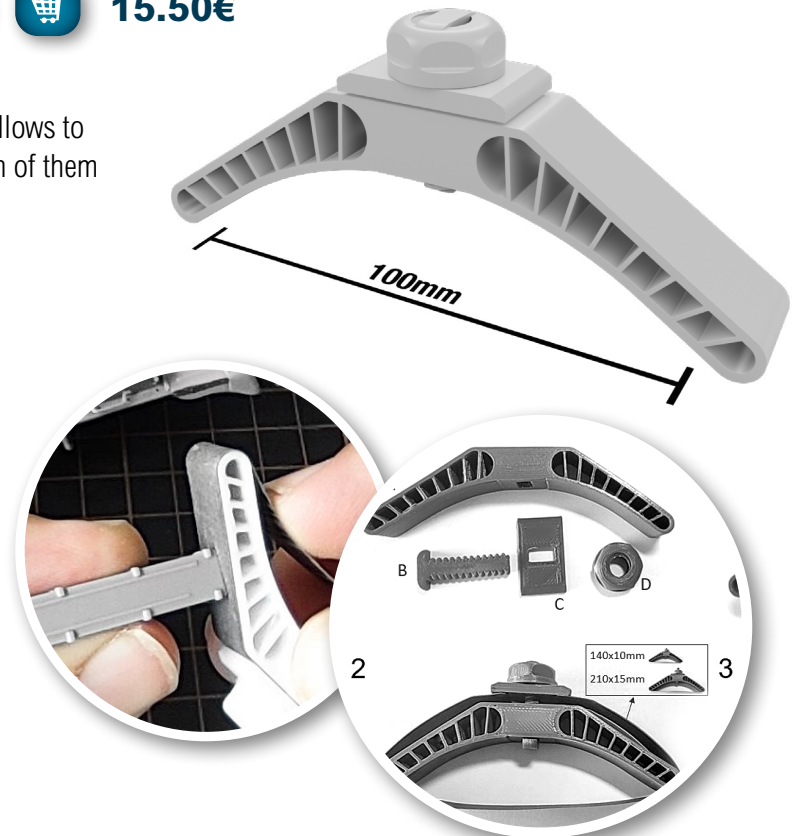

Track Link Jig
Soporte para montaje
de cadenas

MSA03



13€

Tool for assembling individual link tracks, workable or not, made of plastic, resin or metal.

- 2 built-in trays to deposit links or their components, connecting pins, etc.
- Maximum track width: 27mm.
- Removable side stopper.

Herramienta para el montaje de cadenas de eslabones individuales, funcionales o no, de plástico, resina o metal.
2 bandejas incorporadas para depositar eslabones o sus componentes, pines de unión, etc.
Anchura máxima de la cadena: 27mm
Tope lateral extraíble.

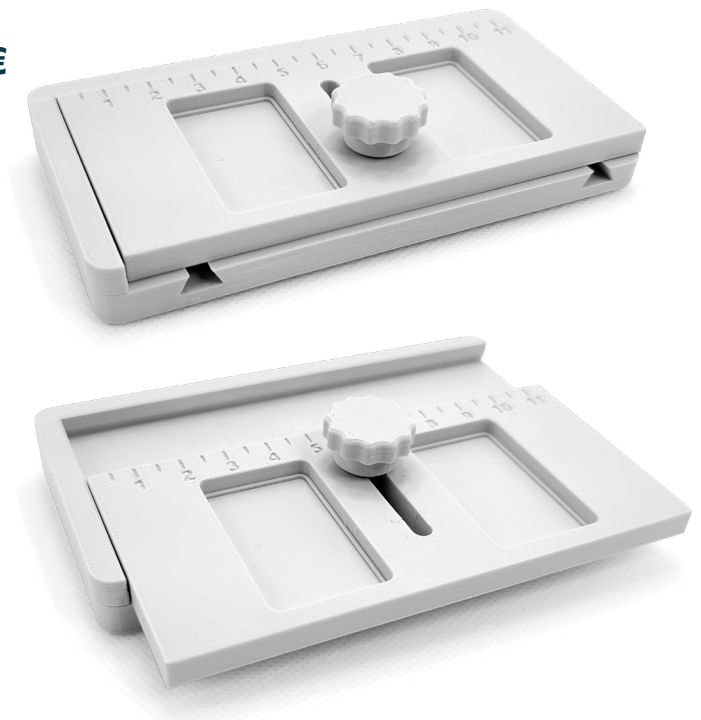

Example 1 King Tiger
Ejemplo 1 King Tiger

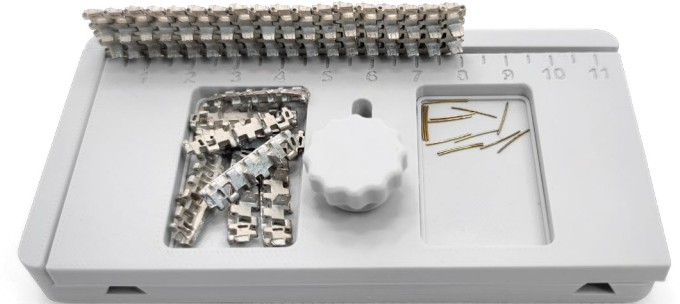

Example 2 T62
Ejemplo 2 T62

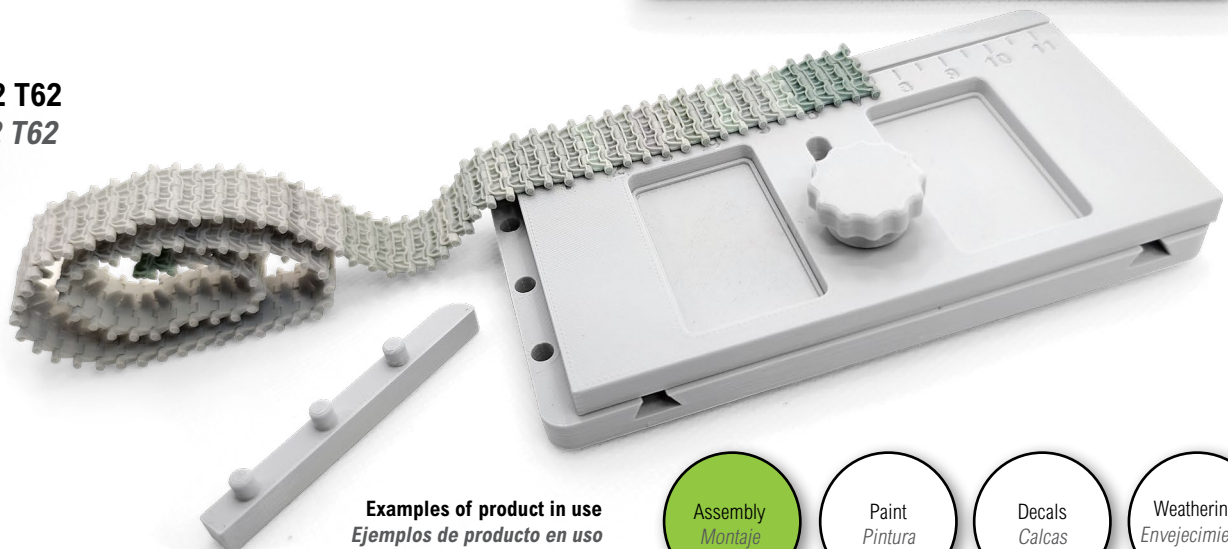

Examples of product in use
Ejemplos de producto en uso

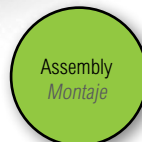

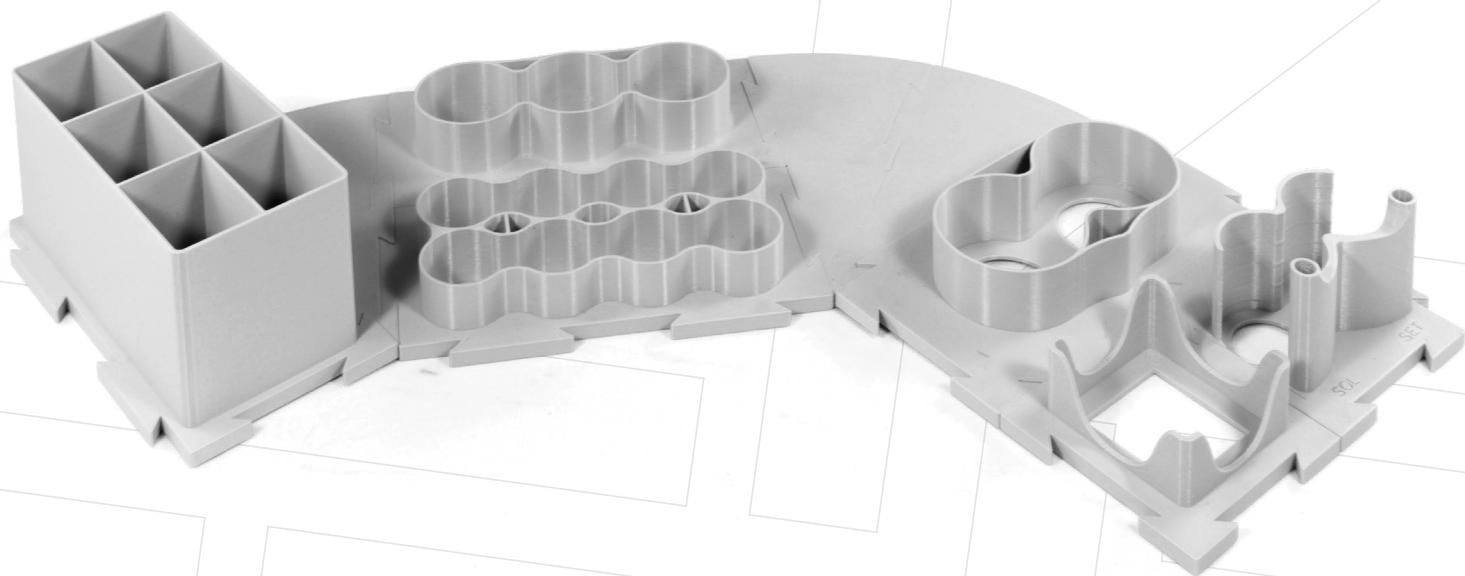

Zed Extensible Program

SETS
SETS

Assembly set
Set de montaje

Set to make easy assembly operations. Expandable with the rest of the components or sets of the ZEP range.

Set para facilitar las operaciones de montaje. Ampliable con el resto de componentes o sets de la gama ZEP.

36.45€

S01



Example of assembly of the components of this set. Accessories not included
Ejemplo de montaje de los componentes del set. Accesorios no incluidos

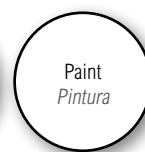
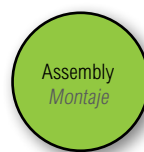

Includes / Incluye

MS101	Microscale holder <i>Soporte Microscale</i>
MS102	Tamiya holder <i>Soporte Tamiya</i>
MS202	Support with departments <i>Soporte con departamentos</i>
MS206	Big tools holder <i>Soporte portaherramientas grande</i>

Painting set
Set de pintura

60.50€

S02

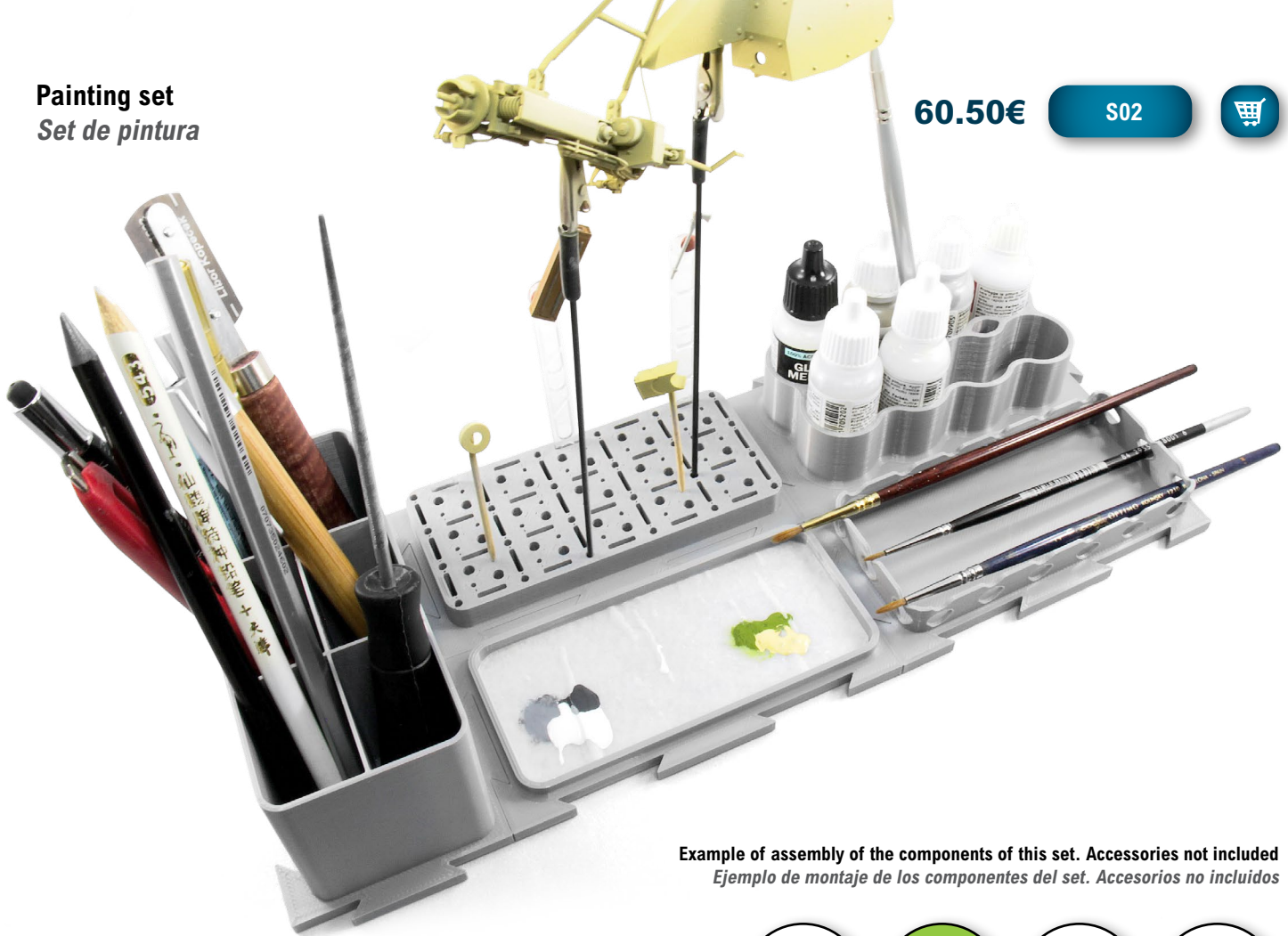

Example of assembly of the components of this set. Accessories not included
Ejemplo de montaje de los componentes del set. Accesorios no incluidos

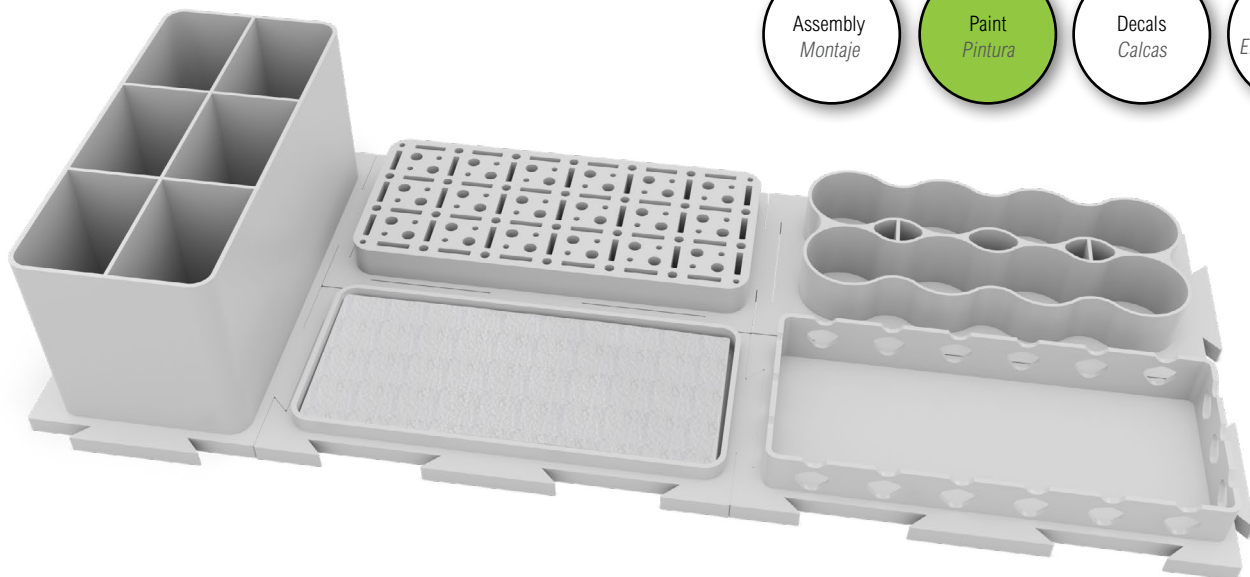
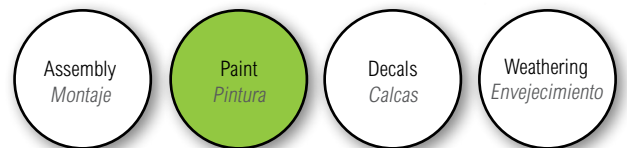

Set to make easy the painting of your scale models.
Expandable with the rest of the components or sets of
the ZEP range.

*Set para facilitar la pintura de tus modelos a escala.
Ampliable con el resto de componentes o sets de la
gama ZEP.*

Includes / Incluye

MS201	Multipurpose palette <i>Paleta multiusos</i>
MS203	Paints holder x8 <i>Soporte para pinturas x8</i>
MS205	Holder for pieces in painting <i>Soporte para piezas en pintura</i>
MS206	Big tools holder <i>Soporte portaherramientas grande</i>
MS207	Brush holder <i>Soporte para pinceles</i>

Decals set
Set de calcas

27.95€

S03



Example of assembly of the components of this set. Accessories not included
Ejemplo de montaje de los componentes del set. Accesorios no incluidos

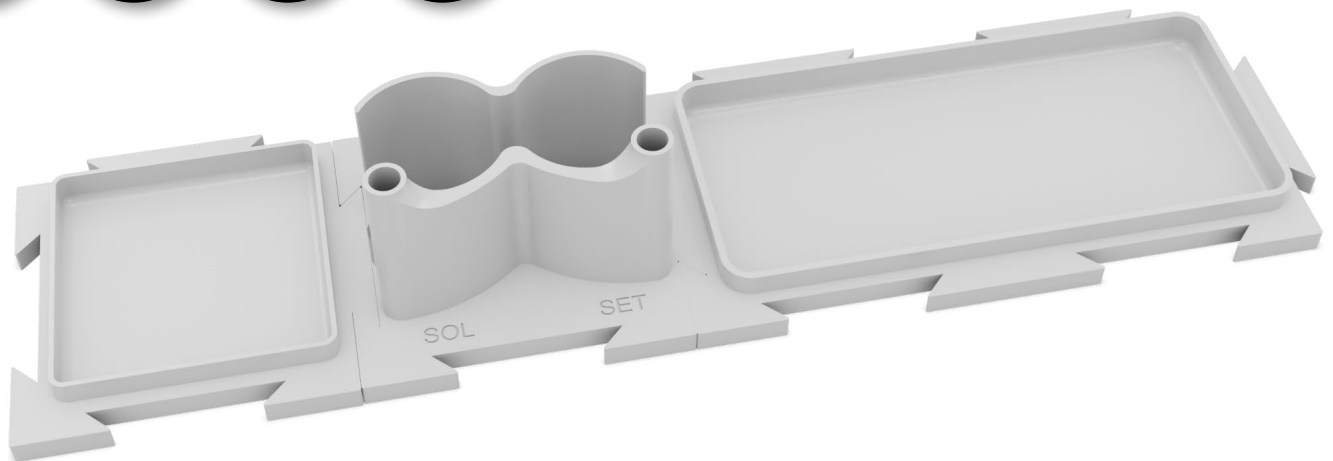
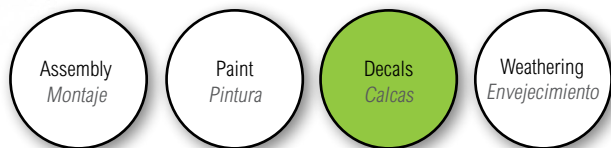

Set to make easy to place the decals of your scale models. Expandable with the rest of the components or sets of the ZEP range.

Set para facilitar la colocación de las calcas de tus modelos a escala. Ampliable con el resto de componentes o sets de la gama ZEP.

Includes / Incluye

MS101	Microscale holder <i>Soporte Microscale</i>
MS104	Small decals holder <i>Base Calcas simple</i>
MS201	Multipurpose palette <i>Paleta multiusos</i>

Weathering set
Set de envejecimiento

60.50€

S04

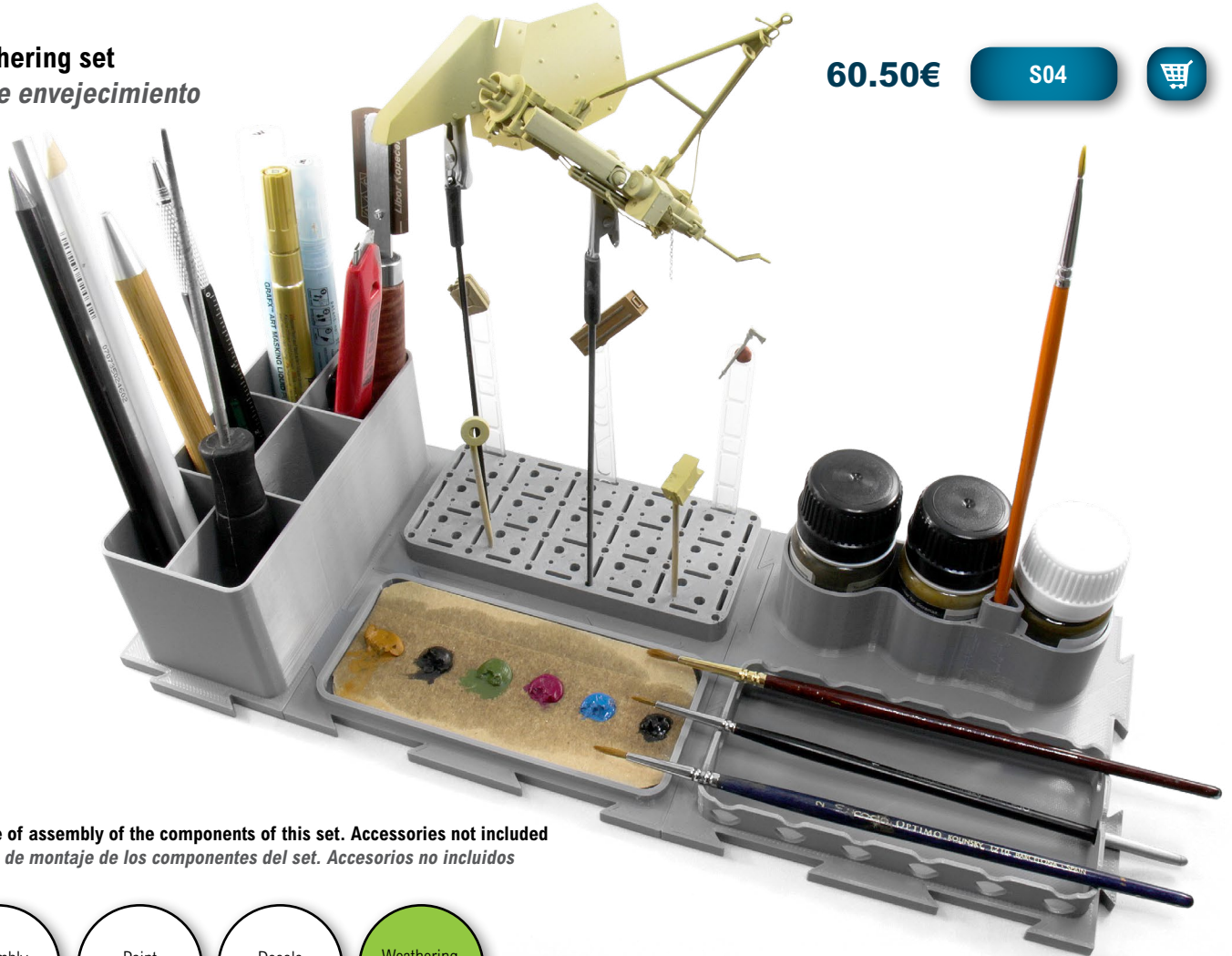

Example of assembly of the components of this set. Accessories not included
Ejemplo de montaje de los componentes del set. Accesorios no incluidos

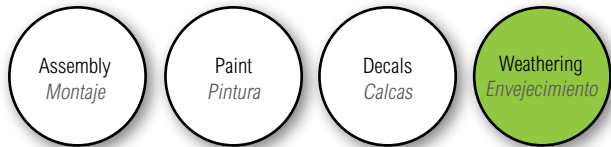

Set to make easy the weathering phase of your scale models. Expandable with the rest of the components or sets of the ZEP range.

Set para facilitar la fase de tratamientos de tus modelos a escala. Ampliable con el resto de componentes o sets de la gama ZEP.

Includes / Incluye

MS201	Multipurpose palette <i>Paleta multiusos</i>
MS204	Weathering holder x3 <i>Soporte para tratamientos x3</i>
MS205	Holder for pieces in painting <i>Soporte para piezas en pintura</i>
MS206	Big tools holder <i>Soporte portaherramientas grande</i>
MS207	Brush holder <i>Soporte para pinceles</i>

Beginners set
Set de iniciación

Set to start modeling with a basic ZEP set. Expandable with the rest of the components or sets of the ZEP range.

Set para iniciarte en el modelismo con un set ZEP básico. Ampliable con el resto de componentes o sets de la gama ZEP.

S05



37.00€

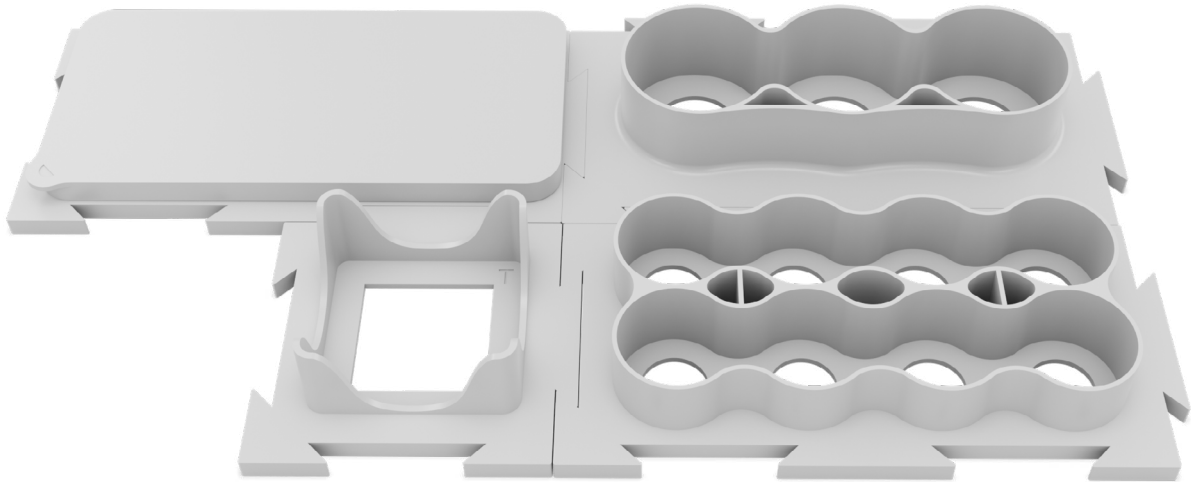

Includes / Incluye

MS102	Tamiya holder <i>Soporte Tamiya</i>
MS201	Multipurpose palette <i>Paleta multiusos</i>
MS203	Paints holder x8 <i>Soporte para pinturas x8</i>
MS204	Weathering holder x3 <i>Soporte para tratamientos x3</i>

Example of assembly of the components of this set.
Ejemplo de montaje de los componentes del set.

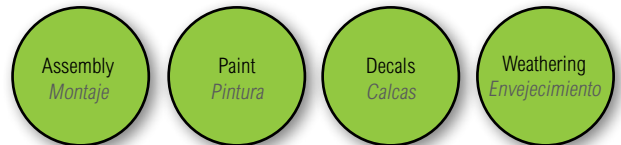

Advanced set
Set avanzado

Set to start modeling with a basic ZEP set. Expandable with the rest of the components or sets of the ZEP range.

119.90€

S06



Set completo para todas las fases del proceso de tu modelo a escala. Ampliable con el resto de componentes o sets de la gama ZEP.

Includes / Incluye

MS101	Microscale holder <i>Soporte Microscale</i>
MS106	Masking tape holder <i>Soporte cinta enmascarar</i>
MS201	Multipurpose palette <i>Paleta multiusos</i>
MS203	Paints holder x8 <i>Soporte para pinturas x8</i>
MS204	Weathering holder x3 <i>Soporte para tratamientos x3</i>
MS205	Holder for pieces in painting <i>Soporte para piezas en pintura</i>
MS206	Big tools holder <i>Soporte portaherramientas grande</i>

MS207	Brush holder <i>Soporte para pinceles</i>
MS208	Solvents holder <i>Soporte para disolventes</i>
MS209	Mixing holder <i>Soporte para mezclas</i>
MSC01	30° connectors set (3+3) <i>Set conectores 30° (3+3)</i>



And what else with ZEP?

¿Y qué más con ZEP?

Every day you could build a different combination with the ZEP components. Your imagination is the only limit. We have thought a lot, but surely you have some special need to which our system could adapt. Send us an email to order@ak-interactive.com and we will help you to develop your idea.

Cada día podrías construir una combinación diferente con los componentes ZEP. El único límite es tu imaginación. Nosotros hemos pensado mucho, pero seguro que tú tienes alguna necesidad especial a la que nuestro sistema podría adaptarse. Envíanos un email a order@ak-interactive.com y te ayudaremos a desarrollar tu idea.

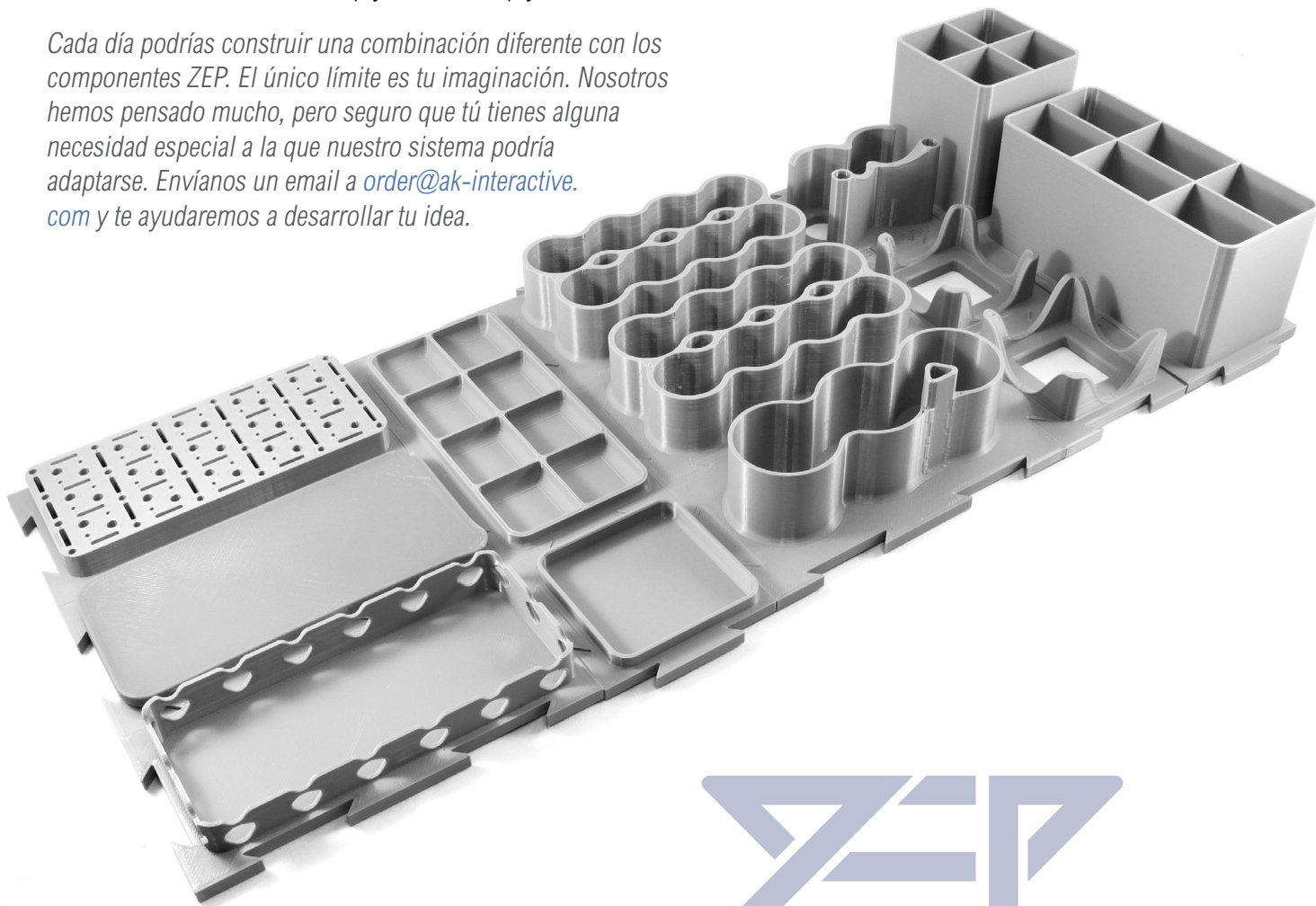

ZEP

ZEP adapts to you ZEP se adapta a tí

Our designs are alive, we continuously add new components and improve the current ones through the ideas of our customers, maintaining their functionality. We can also customize the product for you, change the color or the design according to your needs. Write to us at order@ak-interactive.com

Nuestros diseños están vivos, añadimos nuevos componentes continuamente y mejoramos los actuales a través de las ideas de nuestros clientes, manteniendo su funcionalidad. También podemos personalizar el producto para ti, cambiando el color o el diseño según tus necesidades. Escríbenos a order@ak-interactive.com

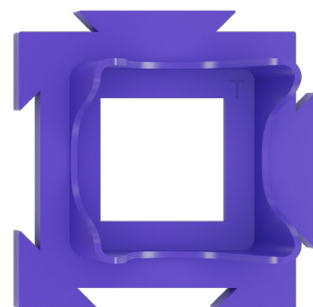
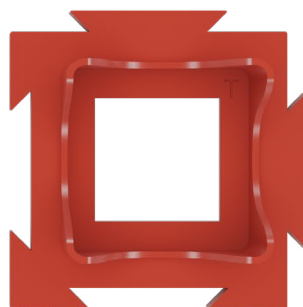
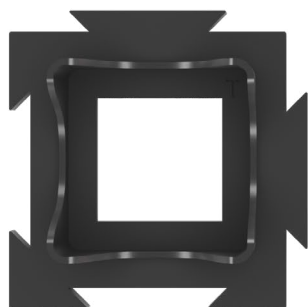
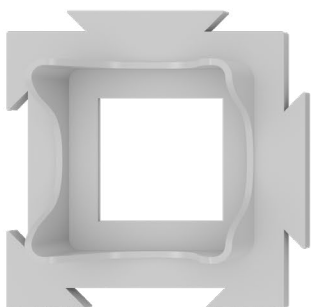

Product guide
Guía de producto

The pieces overlap by 5 mm by the hooking system, varying the final size.
En las piezas se solapan 5 mm por el sistema de enganche variando el tamaño final.

			SUITABLE FOR: ADECUADO PARA:			
Size <i>Tamaño</i>	Reference <i>Referencia</i>	Description <i>Descripción</i>	Assembly <i>Montaje</i>	Painting <i>Pintura</i>	Decals <i>Calcas</i>	Weathering <i>Envejecimiento</i>
1x1	MS101	Microscale holder <i>Soporte Microscale</i>				
	MS102	Tamiya holder <i>Soporte Tamiya</i>				
	MS103	Gunze holder <i>Soporte gunze</i>				
	MS104	Small decals holder <i>Base Calcas simple</i>				
	MS105	Small tools holder <i>Soporte portaherramientas simple</i>				
	MS106	Masking tape holder <i>Soporte cinta enmascarar</i>				
	MS107	Multi container holder <i>Soporte para contenedores</i>				
	MS108	Weathering pencils holder <i>Soporte de lápices de envejecimiento</i>				
2x1	MS201	Multipurpose palette <i>Paleta multiusos</i>				
	MS202	Support with departments <i>Soporte con departamentos</i>				
	MS203	Paints holder x8 <i>Soporte para pinturas x8</i>				
	MS204	Weatherings holder x3 <i>Soporte para envejecimiento x3</i>				
	MS205	Holder for pieces in painting <i>Soporte para piezas en pintura</i>				
	MS206	Big tools holder <i>Soporte portaherramientas grande</i>				
	MS207	Brush holder <i>Soporte para pinceles</i>				
	MS208	Solvents holder <i>Soporte para disolventes</i>				
	MS209	Mixing holder <i>Soporte para mezclas</i>				
MSC01	30° connectors set (3+3) <i>Set conectores 30° (3+3)</i>					
MSC02	Desk edges (6x3) <i>Bordes de escritorio (6x3)</i>					



Distributed by

